

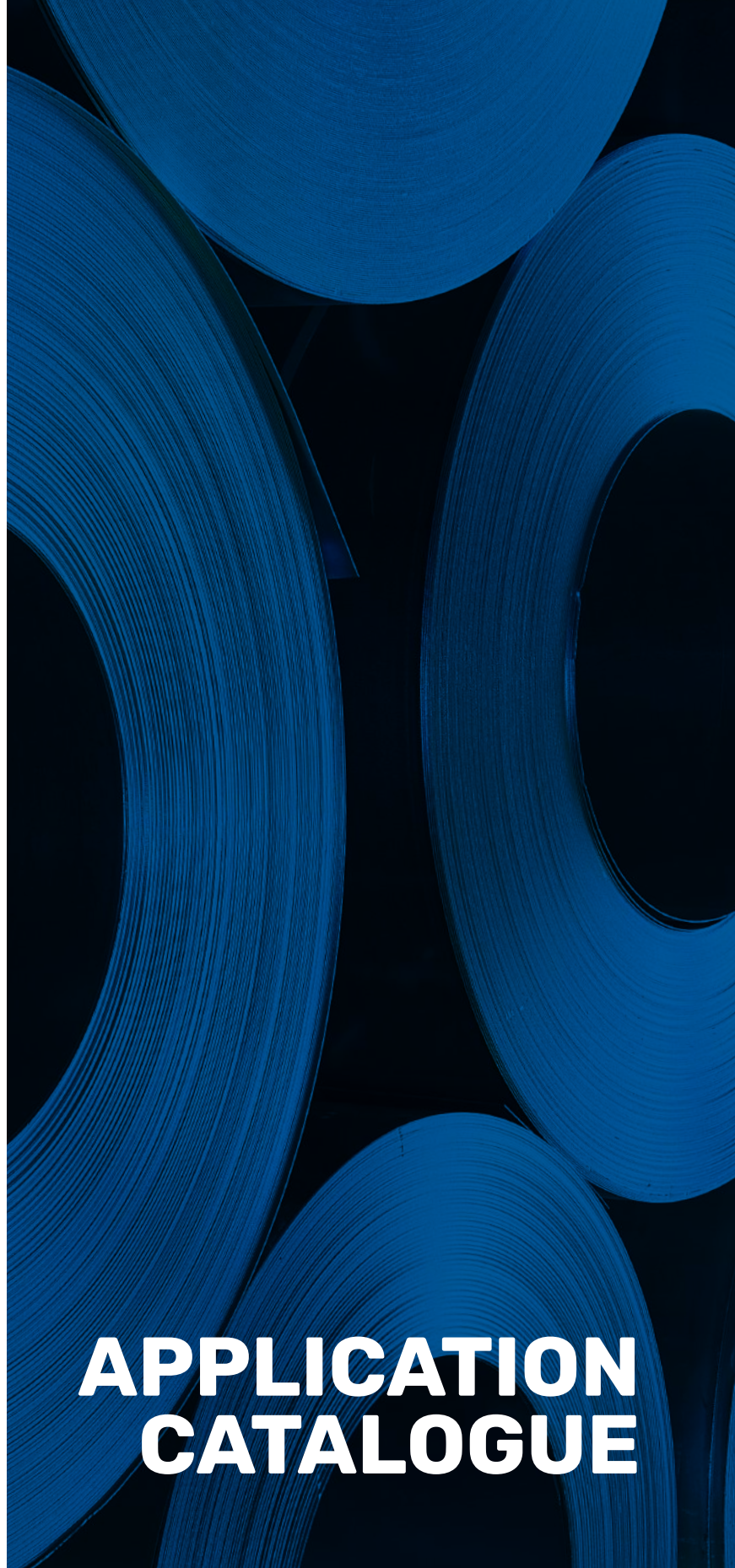

SUSPENDED CEILINGS
PARTITION WALLS
WALL CLADDING
EXTERIOR WALL SYSTEMS

www.umsmetal.com.tr



APPLICATION CATALOGUE

#onestepahead

1999

Founded in Ankara Ostim OIZ as a company trading in galvanized and painted galvanized sheets.

2005

Based on an investment decision, the first and only Steel Service Center was established in Ankara Ostim OIZ.

2006

Crowned the importance it attaches to quality by obtaining TS EN ISO 9001 Quality Management Certificate.

2013

With the new investment decision, started investment in counters that produce plaster profiles, plasterboard profiles, exterior wall profiles and accessories.

2018

Taking new steps with regard to quality, besides TS EN ISO 9001 Quality Management Certificate, obtained TS EN ISO 14001 Environmental Management Certificate, TS OHSAS 18001 Occupational Health and Safety Management Certificate and TS EN 15804 Environmental Product Declaration.

ABOUT US

UMS Uğur Metal Sanayi was founded in 1999 at Ankara Ostim OIZ for trading in galvanized and painted galvanized sheets. Within a very short span of time, UMS, thanks to its principled and high quality sheet trading approach, became an industry brand that makes the highest sales volume in its region.

2005 Growing by taking a new investment decision in 2005, UMS established the first and only Steel Service Center in its region. Having cut-to-length line, trapeze line and slitting line with Steel Service Center, UMS has been providing high quality and rapid service for specific-measure galvanized sheet demands.

2006 UMS, crowning the importance it attaches to quality by obtaining TS EN ISO 9001 Quality Management Certificate, has been a Steel Service Center that makes a difference with its quality certificate.

Continuing its production with a full head of steam and the same determination, today, UMS performs its production activities with its modern and fast counters by galvanized steels and non-alloy structural steels which are suitable for cold forming, with an annual production capacity of 120 thousand tonnes.

Keeping on growing and improving in the industry through its investments, UMS, with its 150 million-meter capacity for plaster profiles, plaster board profiles, external wall profiles and accessories, created with the new counters and production lines added in 2013, has become the fastest producer with the highest production volume in Turkey.

UMS, adopting customer satisfaction, after-sale services, quality and reliability as its core principles, continues to add to product diversity and make difference in the industry with its understanding of always being One Step Ahead in innovation, technology and value attached to development.





VISION

To meet demands and expectations of our customers to the highest extent by providing quality, reliable and qualified service and to ensure satisfaction of our customers and employees.

MISSION

Our mission is to be always one step ahead and the best. We imply by being the best to be a model company which has ensured customer satisfaction and is preferred by its customers, sensitive to environment, friendly and having social responsibility.

OUR PRINCIPLES

As UMS, we operate based on the following principles



Acting with a team spirit.



Attaching importance to quality, training, innovation and creativity.



Competitiveness.



Giving customer satisfaction the highest priority.



Giving customer satisfaction the highest priority.



Acting based on trust.



Creating a peaceful working environment.



Being sensitive to the environment and environmental values.



Respecting the rules.



Keeping updated by applying innovations and modern technology.



Always racing to the top.

INTEGRATED MANAGEMENT SYSTEM POLICY

QUALITY POLICY

It is our fundamental principle to adopt quality as a way of life for the purpose of providing the highest quality products and services in order to maintain our respect to our customers, and our existence.

We believe that factors that raise quality include a participatory working environment, qualified and trained staff, healthy working conditions, sensitivity to environment, keeping up with the times and changing conditions.

Therefore, our quality policy commits;
To increase awareness of quality and environment through continuously training all our employees, create a safe working environment, apply innovations and modern technology,

To provide our customers with high quality products within the shortest time, with the highest quality, performance, product reliability and value guarantee all the time,

To comply with national and international standards and legislation regarding the products,

To implement the quality management system we have established and continuously improve its effectiveness.

ENVIRONMENTAL POLICY

Fundamental environmental policy of UMS Uğur Metal Sanayi and its commitments are as follows:

- To monitor legislation during our activities and develop our system based on continuous improvement principle,
- To ensure operation of our company in line with our environmental policy,
- To ensure minimization of the impacts on natural resources and environment,
- To use state-of-the-art technology in order to protect environment and not to contaminate it, to use environmentally-friendly chemicals during waste water treatment,
- To act in accordance with continuous improvement principle.

OCCUPATIONAL HEALTH AND SAFETY POLICY



UMS Uğur Metal Sanayi has set ensuring safe working conditions in all its activities during rendering its services and safe completion of its operations as a priority objective. All operational activities are to be controlled effectively within the frame of OHS Management System in order to prevent personal injuries, loss of life, possible harms to health and property and destruction of environment.

UMS Uğur Metal Sanayi commits to make necessary regulations for all its services in order to achieve following objectives during the course of its operations. Accordingly, it is our Company Policy:

- To ensure safe operation of services provided in accordance with national and international rules and implementations,
- To analyze and determine the root causes for accidents and develop procedures, and thus, to achieve "Zero Accident" objective through sustainability of operational development,
- To ensure continuous improvement of OHS management and OHS performance by preventing injuries and health disorders,
- To prevent physical injuries and loss of life by ensuring following health and safety rules and to deliver necessary trainings for the staff,
- To evaluate performance of the management and keep the standards at the highest level by constantly updating the system,
- To take necessary measures against all defined risks, evaluate the measures taken and make required modifications,
- To draw up emergency response plan and keep necessary human resources and other equipment available at any time, revise the plan and make scheduled/unscheduled drills ensuring active participation of all staff in drills.

Our Objectives on the pathway to this goal involves,

- Continuous improvement,
- The shortest time,
- The best price,
- The highest quality,
- Healthy and safe working environment,
- Continuous training.

QUALITY CERTIFICATES



TS EN ISO 9001-2015



TS OHSAS 18001-2007



TS EN ISO 14001-2015



UMS POWER



TS EN 14195

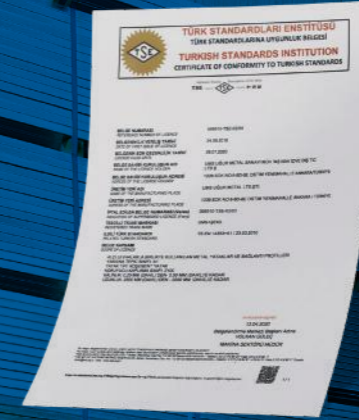

TS EN 14353+A1



TSE K 236

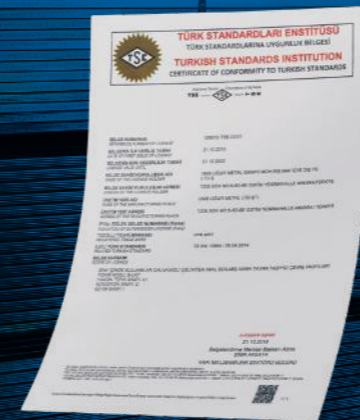

TS EN 13964



EPD



CE

MESSAGE FROM THE MANAGING DIRECTOR



Hakkı USTA

Managing Director
MSc Mechanical Engineer

Flat product sheet industry, one of the most important materials for construction sector and also essential for profile and accessories production by UMS's Steel Service Center, is among the rapidly changing industries due to the effect of global trends.

Global trends, from time to time, adversely affect sales and pricing policies of entities within the industry, thereby leading to price-indexed results instead of quality-indexed ones in provision of products/services. These results bring along an understanding that features price but not quality under competitive conditions and cause an adverse effect.

Despite all these adverse effects, UMS keeps up-to-date with its counters equipped with cutting-edge technology in production lines and continues its technological investment processes. Based on its management approach aware of importance of digitalization and high technology in a developing and transforming industrial sector and its effect on efficiency and satisfaction of customers' expectations, UMS carries on its systemic transformation by meeting requirements of the standards.

Taking strategic steps for the future with its R & D investments, UMS acts based on the philosophy of being one step ahead by designing innovative products, molds and high-tech counters.

UMS is one of the exceptional companies which have a Steel Service Center within their bodies and also design and manufacture high-tech roll-form counters they use by themselves.

UMS, performing its domestic sales and marketing operations with its TSI certified products, also produces products that are in compliance with European standards and provides products/services for many countries in Asia, Africa and Europe within the scope of its export operations which have been growing in importance in recent years.

While consistently strengthening its competitiveness with planned investment strategies, UMS adopts a managerial approach which offers a healthy working environment for its staff, creates a network of qualified staff by training its staff and which respects its customers and environment.

As part of this managerial understanding, I would like to thank and pay my respects to our esteemed workmates who have contributed greatly to our company to achieve its success up until today and are committed to their work with love and respect as well as to their families, our customers, suppliers and all shareholders.

TABLE OF CONTENTS

SUSPENDED CEILING SYSTEMS	17
DOUBLE FRAME SUSPENDED CEILING APPLICATION	23
APPLICATION OF SUSPENDED CEILING WITH BRACKET	35
OMEGA PROFILE SUSPENDED CEILING APPLICATION	45
SUSPENDED CEILING APPLICATION WITH CEILING C47 PROFILE	55
PARTITION WALL SYSTEMS	65
WALL CLADDING SYSTEMS	91
WALL CLADDING SYSTEM DEPENDENT ON EXISTING WALL	97
WALL CLADDING SYSTEM INDEPENDENT OF EXISTING WALL	105
EXTERIOR WALL SYSTEMS	105
CT PROFILE	119
M PROFILE	127



SUSPENDED CEILING

Suspended ceiling is a ceiling coating system preferred in order to provide sound and heat insulation, hide electrical wiring, plumbing installations, avoid possible hazards by uncovered systems and get a decorative view. The most important components of the system are the carrier ceiling profiles. Selection of profile may vary depending on the choice of system. UMS has all connection details and production diversity for double frame suspended ceiling systems, suspended ceiling systems with bracket, suspended ceiling systems with omega profiles and single frame suspended ceiling systems.

SUSPENDED CEILING SYSTEMS

TYPES

Suspended ceiling applied to reinforced concrete floor

This is a type of suspended ceiling applied to reinforced concrete surface by means of metal carrier frame and steel wall plugs.

Suspended ceiling applied to hollow-tile floor slab

This is a type of suspended ceiling applied to ribbed joists between the hollow blocks by means of metal carrier frame and steel wall plugs.

Suspended ceiling applied to timber floor

This is a type of suspended ceiling where one edge of metal carrier frame is put over the flooring and fastened with nut.

Suspended ceiling applied to steel floor

This is a type of suspended ceiling applied through fastening metal carrier frame to the existing steel flooring by means of welding and rivet.

FEATURES

- Provides a decorative view,
- Facilitates installation of electrical and plumbing lines,
- Minimizes risk by adapting to the movements of the building during an earthquake,
- It is light; does not load weight to carrier system,
- Contributes to sound and heat insulation,
- Gains a decorative surface by concealing electrical wiring and plumbing installations,
- Stretch ceiling detail is used to provide cove lighting,
- At least 40% lighter compared to concrete ceiling,
- Can be produced at any sizes in UMS production lines according to project details.

FIELDS OF USE

- Business and shopping centers
- Hospitals
 - Industrial constructions
 - Housings
 - Office and management buildings
 - Restored and renovated buildings
 - Hotels
 - Performance centers (Theatres and cinema halls, conservatories etc.)

COMPONENTS OF THE SYSTEM

Ceiling U Profile

It is a non-load bearing ceiling profile needed for alignment of carrier Ceiling C profiles in the metal construction built to make suspended ceiling and for leveling of the system.

Ceiling C Profile

Divided into two as main carrier profile and auxiliary carrier profile. Main carrier Ceiling C profile is the term used for Ceiling C profile hung on hanger clip and placed in the upper point of the system. Auxiliary Carrier Ceiling C Profile is the term used for Ceiling C Profile that is fastened to the main carrier Ceiling C profile by the help of clip and on which plasterboards are mounted.

Omega Ceiling U Profile

It is a main carrier ceiling profile to which auxiliary carrier Omega profiles are fastened and which is hung onto the ceiling using hanging clip or L corner profile.

Omega Profile

It is a ceiling profile that forms the basis for plasterboard assembly by being fastened to main carrier Omega Ceiling U profile and that carries gypsum plasterboards.

Ceiling C47 Profile

It is a carrier ceiling profile which is fastened to the reinforced concrete ceiling by means of special clips or hanger clip and where plasterboards are mounted to.

Extension Piece

An accessory used to splice two Ceiling C Profiles.

Wall plug-Screw

A fastener used to wall-mount Ceiling U profiles.

Steel Wall Plug

A fastener used to wall-mount suspension rod.

Suspension Rod

An accessory used to carry spring hangers.

Hanger clip

Accessory used to hold Main Carrier Ceiling C profiles.

Bracket

Accessory used to hold Main Carrier Ceiling C profiles.

Sound Insulation Tape

Insulation tape applied to the face of Ceiling U Profiles that touches the wall in order to provide sound insulation for vibrations caused by construction.

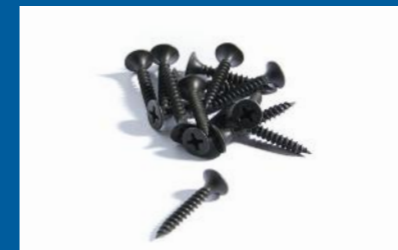
Sharp Point Screw

In plasterboard applications, a type of screw used to fix plaster boards onto auxiliary carrier Ceiling C profiles up to 0,7 mm wall thickness.

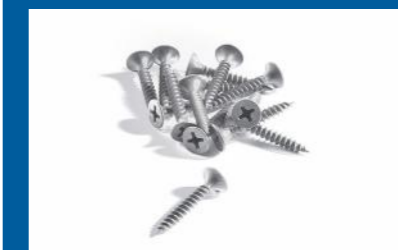
Metal-Metal Screw

Type of screw used to mount extension piece into auxiliary and main profiles or brackets into main profiles.

Clip

Accessory used to get Auxiliary Ceiling C profiles carried by main carrier Ceiling C profiles.

Insulation Material

Mineral wool of different density and thickness values used to increase heat insulation, sound insulation and resistance to fire.



Plasterboard

Multi-purpose construction boards, coated with cardboard on both faces, with plaster in the center. There are 4 different types of plasterboard which are standard, water resistant, fire-resistant and water and fire resistant plasterboards. Due to high air permeability, provides significant contribution in balancing ambient humidity, and in ensuring sound and heat insulation when used with proper insulation material.

Joint Tape

A type of netting used to equally block joints remaining between plasterboards using joint sealant and to prevent cleavage at the joint points.

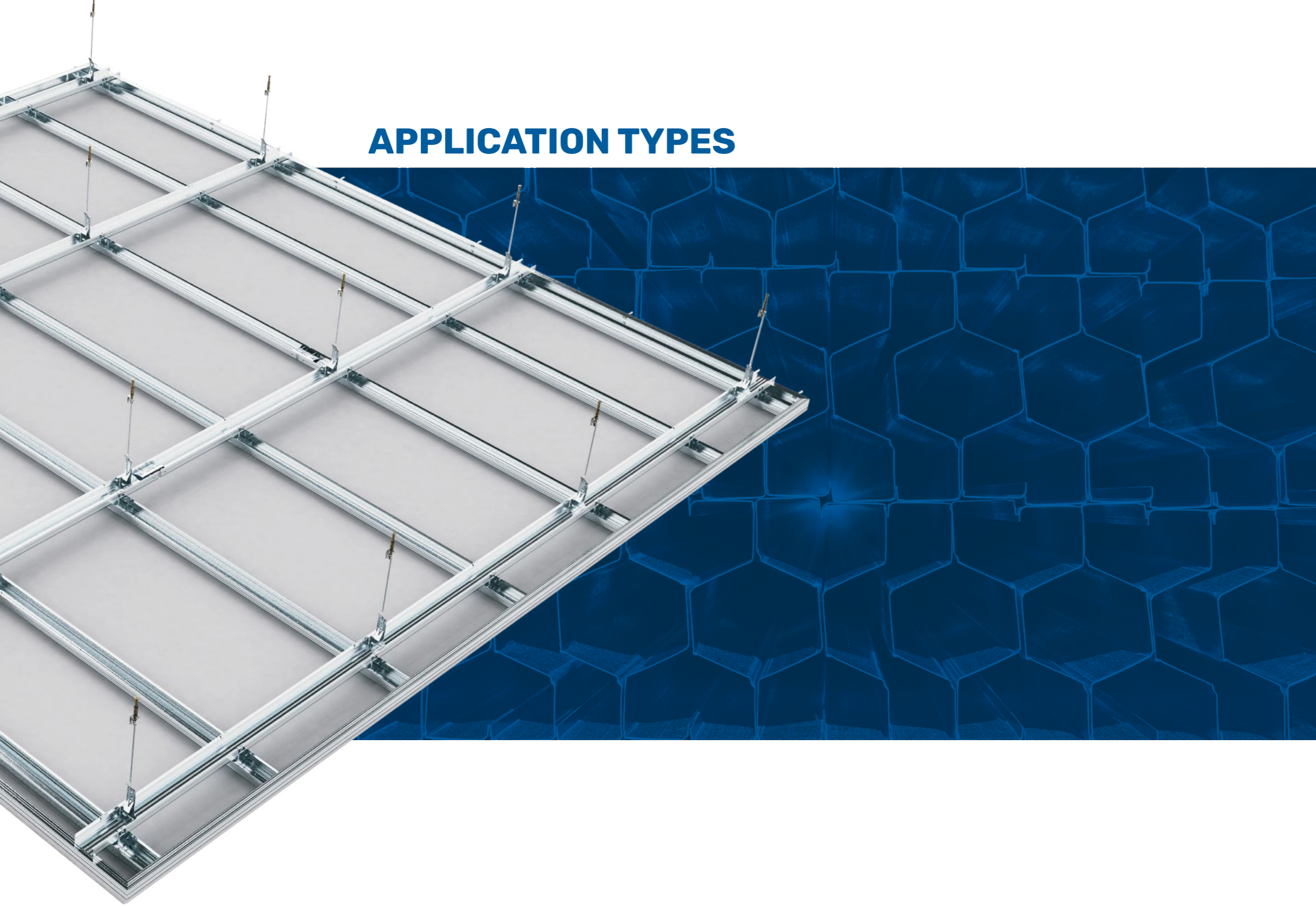
APPLICATION TYPES



DOUBLE FRAME SUSPENDED CEILING APPLICATION

It is a ceiling system consisting of auxiliary components like hanger clip, suspension rod, clip, and Ceiling U, Ceiling C Profiles and plasterboards mounted on these profiles. Ceiling C Profiles are divided into two as main carrier profile and auxiliary carrier profile. Ceiling C profile which is directly fastened to suspension rod and hanger clip is called main carrier profile while Ceiling C profile which provides a surface for fastening plaster boards is called auxiliary carrier profile. Ceiling U profile is intended to provide guidance for main carrier Ceiling C profiles and form a framework for auxiliary carrier C profiles.

APPLICATION

UMS has specified limit values to be taken into consideration for application of double frame suspended ceiling on the next page. Analysis table on the next page can be consulted for the quantity of materials to be consumed when single layer plasterboard is used.

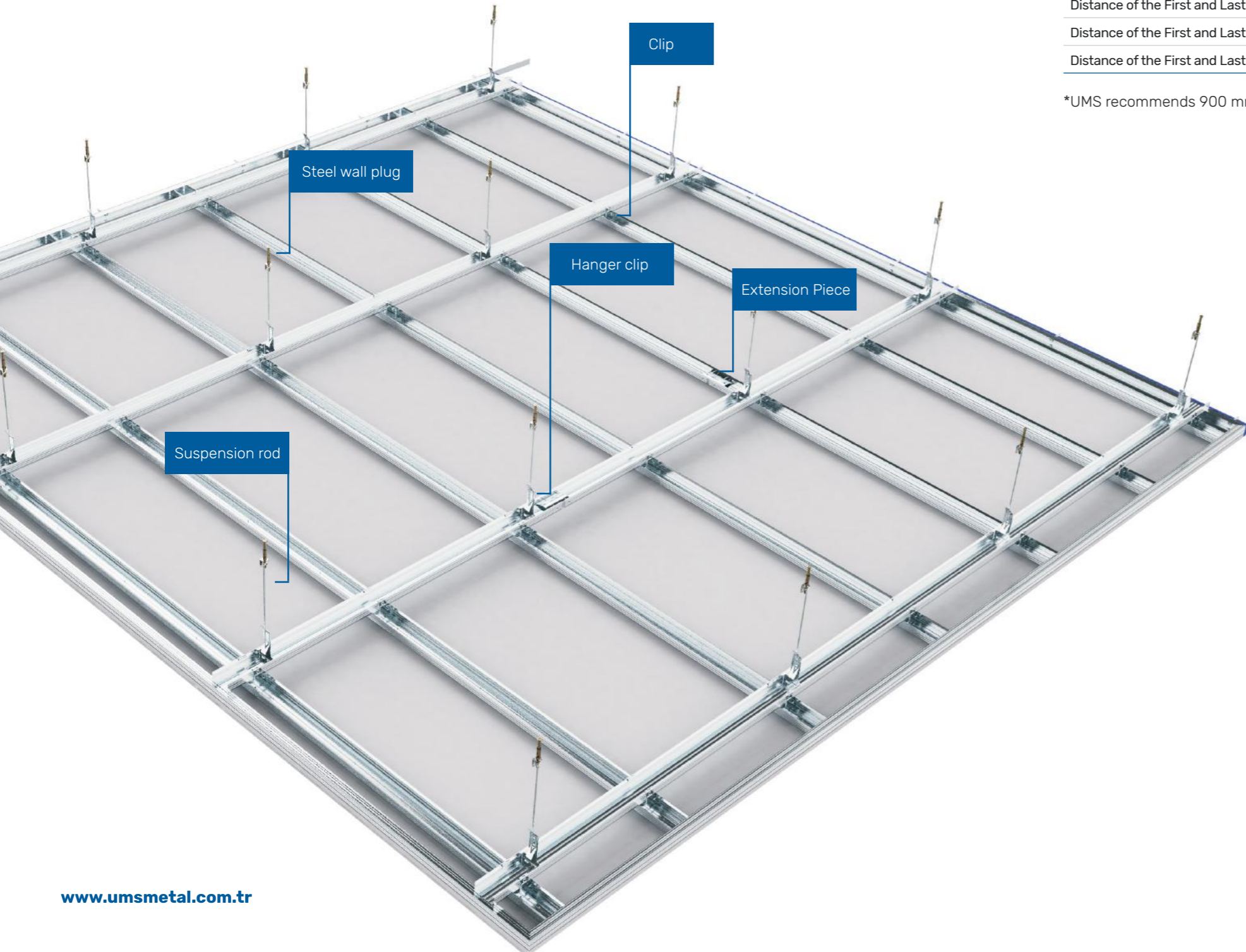

For proper application,

LIMIT VALUES FOR DOUBLE FRAME SUSPENDED CEILING

DESCRIPTION	LIMIT VALUE
Profile Size:	27/60/27 mm (Main and Auxiliary Carrier Ceiling C Profile)
Main Carrier Profile Range:	must be maximum 1100 mm
Suspension Rod Spacing:	must be maximum 1200 mm
Auxiliary Carrier Profile Spacing:	must be maximum 500 mm
Screw Spacing:	must be maximum 300 mm
Distance of the First and Last Main Carrier Profile to the Parallel Wall:	must be maximum 150 mm
Distance of the First and Last Auxiliary Carrier Profile to the Parallel Wall:	must be maximum 100 mm
Distance of the First and Last Suspension Rod to Perpendicular Walls:	must be maximum 250 mm

*UMS recommends 900 mm and below for suspension rod axial spacings.

MATERIAL ANALYSIS FOR DOUBLE FRAME SUSPENDED CEILING CONSTRUCTED USING

DESCRIPTION	1 m ² CONSUMPTION
Plasterboard	1,05 m ²
Ceiling C Profile:	3,6 m
Ceiling U Profile:	1,3 m
Hanger Clip:	1,7 pcs
Suspension Rod:	1,7 pcs
Clip:	5,8 pcs
Extension Piece:	0,7 pcs
Joint Tape:	1,8 m
Drywall Screw:	16 pcs
Steel Wall Plug:	1,7 pcs
Plastic Wall Plug, Shim, Screw:	1 pcs
Jointing Plaster:	0,4 kg
Satin Finishing Plaster:	1 kg/ m ²
Insulating Tape:	1,3 m
Insulating Material (Optional):	1,05 m ²
Corner Profile (Corner Tape):	According to technical details of the ceiling

*Consumptions may vary depending on project details.

Order of operations given below should be followed for a complete application.

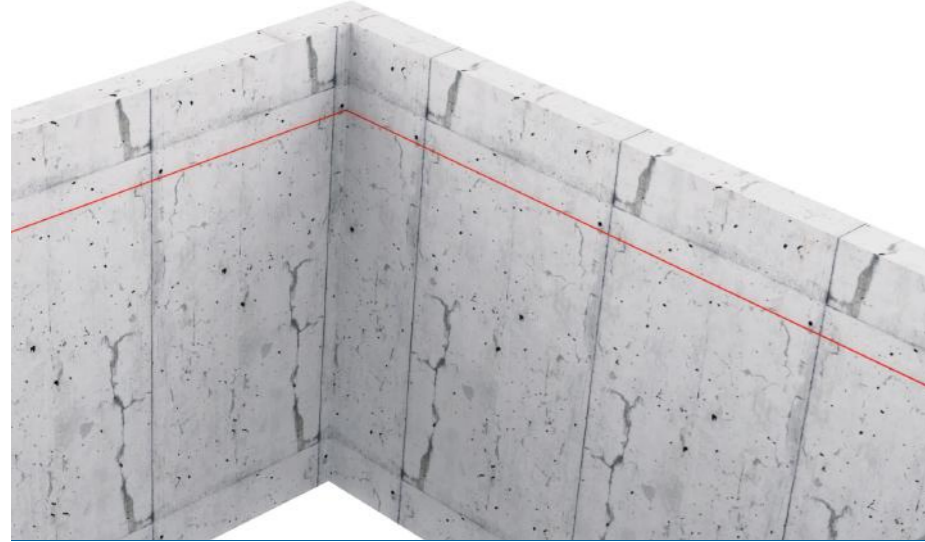

STEP 1

Suspended ceiling elevation is determined using auxiliary equipment including laser, chalk line, water balance.



STEP 2

Ceiling U profiles, in accordance with suspended ceiling elevation, are fixed onto the walls using suitable wall plugs and screws, with a distance of 50 mm from both ends, with a spacing of 600 mm, as insulating tape applied to the parts that touch the wall.

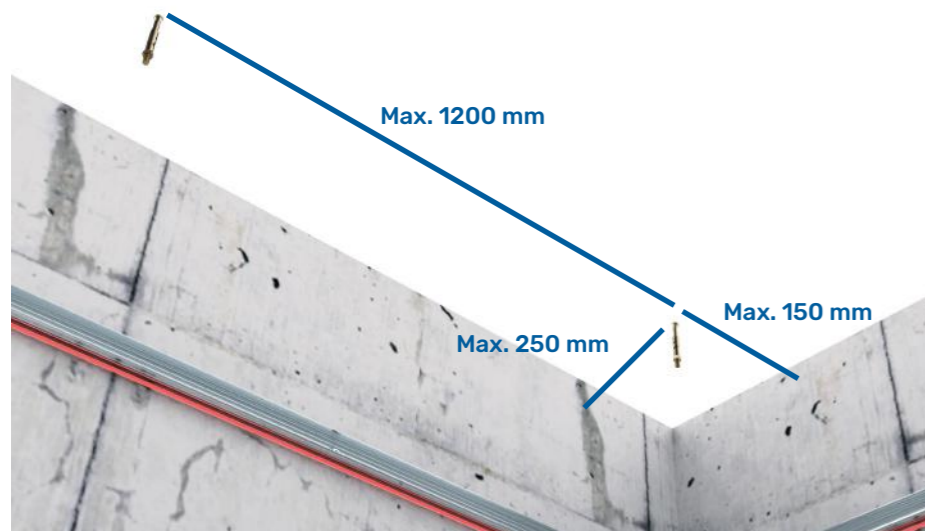

STEP 3

Main Carrier Ceiling C Profile is planned parallel to the lengthier wall of the room, the first suspension rod position is marked on the ceiling surface, taking maximum 150 mm from the first and last profile walls and maximum 250 mm from the perpendicular walls. The second suspension rod is taken maximum 1200 mm from the perpendicular wall and then positions of suspension rods are marked on the ceiling surface so that a distance of 1200 mm is left between each suspension rod. Marked suspension rod positions are drilled and steel wall plugs are mounted.



STEP 4

Suspension rods are cut in accordance with the project so that they do not exceed 2000 mm in length and mounting is completed by pinning them into the existing wall plugs with nuts.



STEP 5

All hanger clips are hung on suspension rods in accordance with suspended ceiling bottom elevation.



STEP 6

Main carrier Ceiling C profiles are positioned to be over the Ceiling U profiles and not to touch the wall and they are affixed to hanger clips, locked and suspended. (Profiles should not be screwed to each other after mounting.)

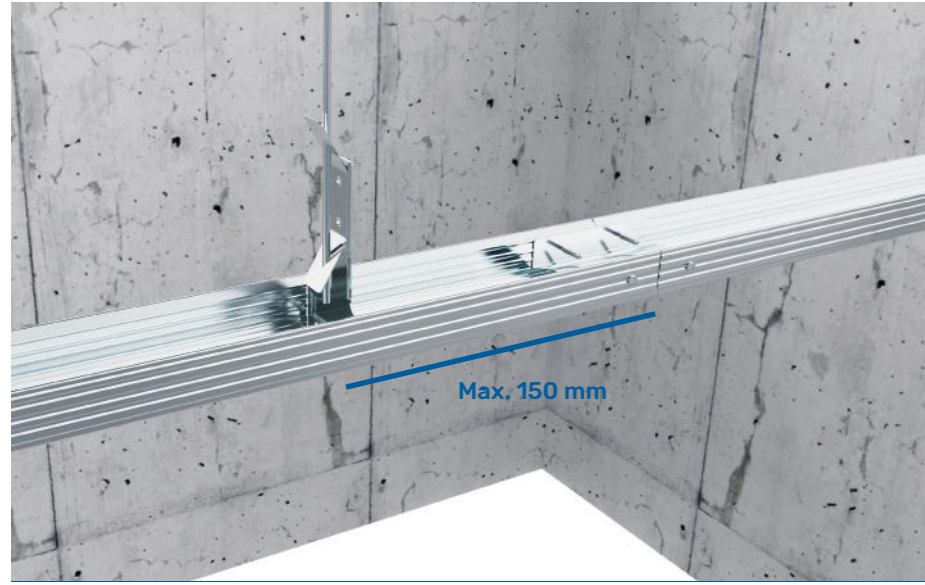

STEP 7

In case the length of Main Carrier Ceiling C Profile is shorter than application distance, two Ceiling C Profiles are attached using extension piece. Places of extension piece should be set so as to be maximum 150 mm to the hanger clip.

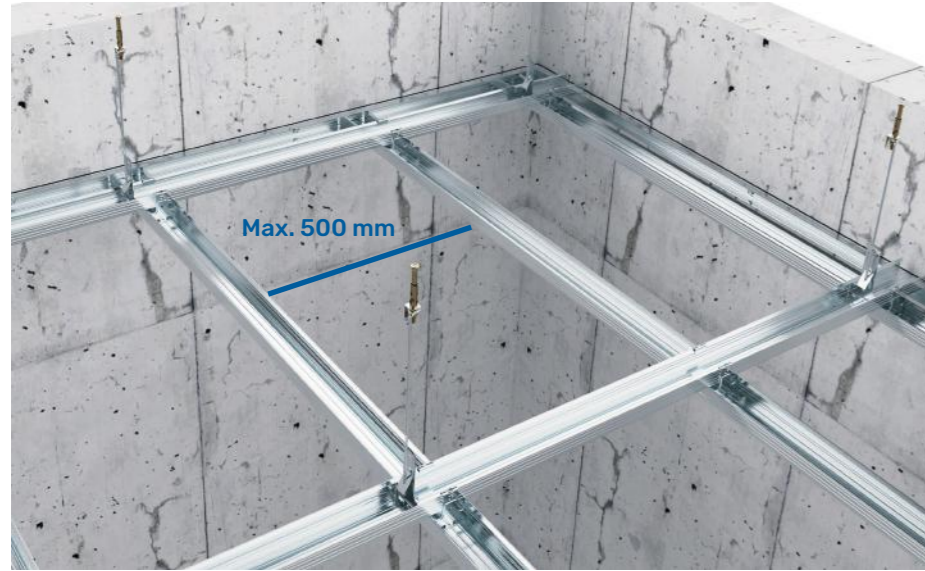

STEP 8

Auxiliary Carrier Ceiling C Profiles are fastened to Main Carrier Ceiling C Profiles using clips, with a distance of maximum 500 mm to each other.

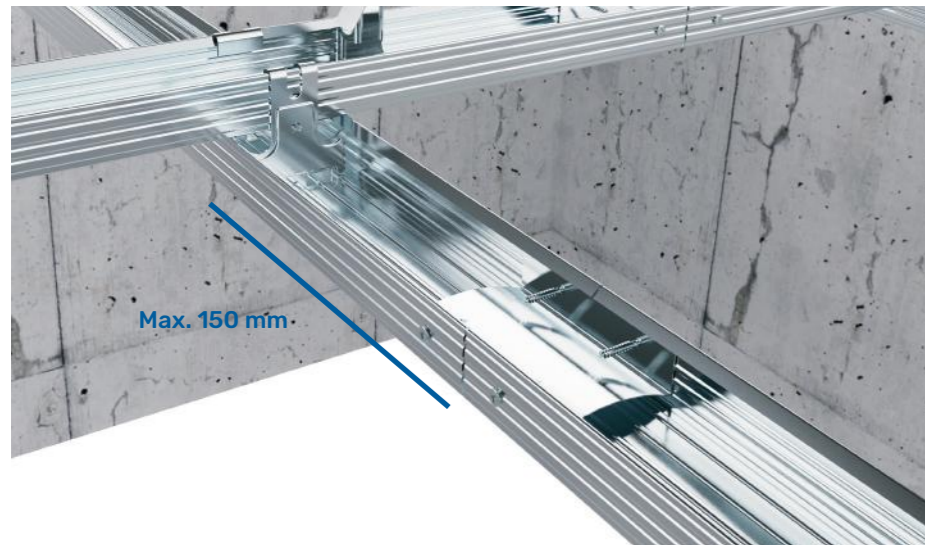

STEP 9

For lengths where a single part cannot pass through at joining points of Auxiliary Carrier Ceiling C profiles, channel connectors are used. Channel connectors are fixed to both profiles from the sides that touch the profile with metal-metal screws and aligned zigzag in parallel profiles. Place of channel connectors should be maximum 150 mm from the clips.

Double frame suspended ceiling system is completed.

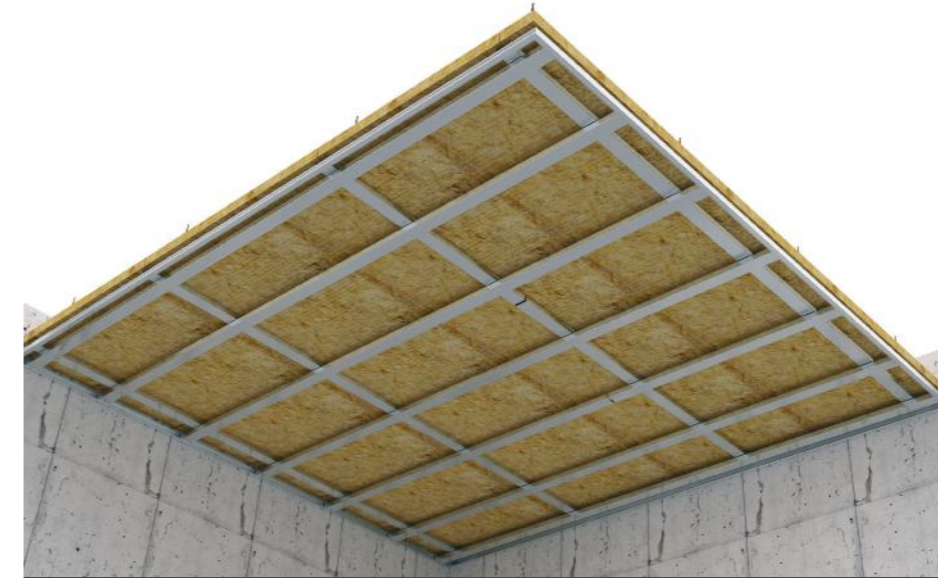

*Following steps are written with reference to plaster board application. Order and content of steps may vary when different materials are used.

STEP 10

Insulating materials are placed on Main Carrier profiles in accordance with the project.

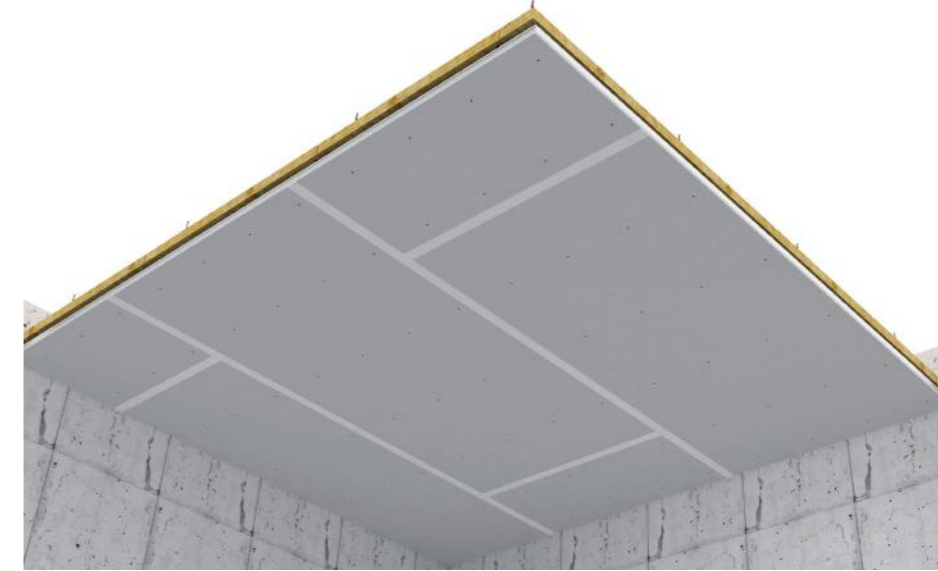

STEP 11

Plaster boards are cut according to the project. Cut plaster boards are mounted onto Auxiliary Carrier Ceiling C profiles in a zigzag way, with suitable screws and spaces between screws. Plaster board joints are covered using joint tapes of appropriate thickness and width according to the project.

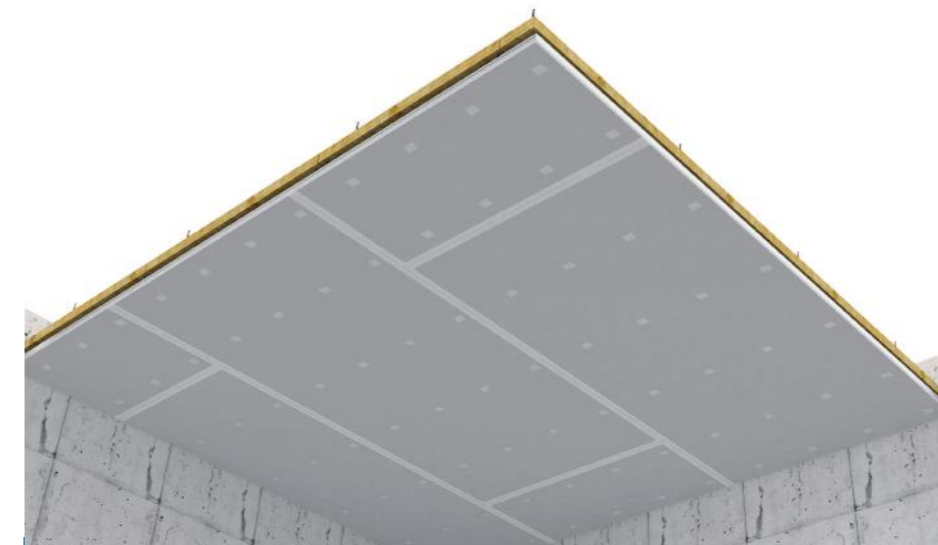

STEP 12

Covered joints and screw heads are filled with suitable jointing plaster, after the filling plaster dries out, treatment area is sandpapered and leveled with the board.

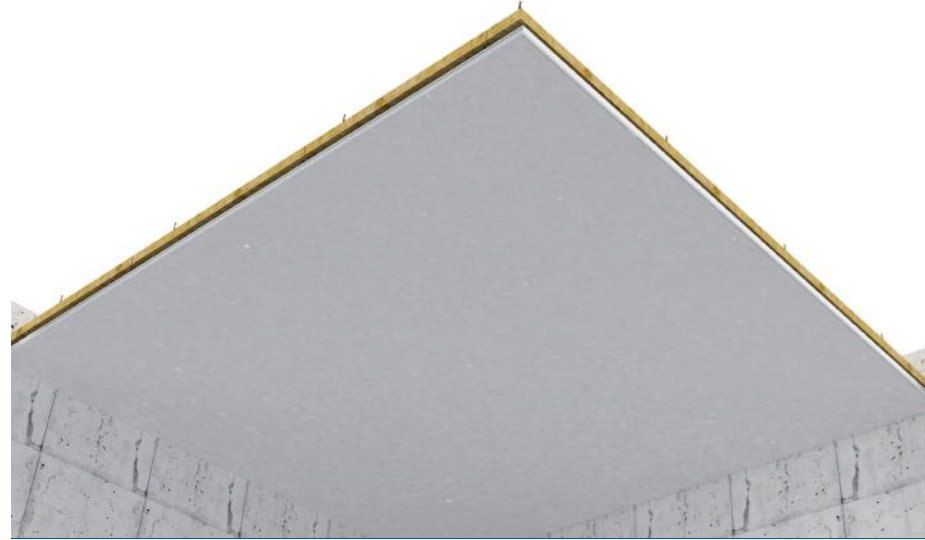

STEP 13

Satin plaster is applied, the surface is sandpapered..

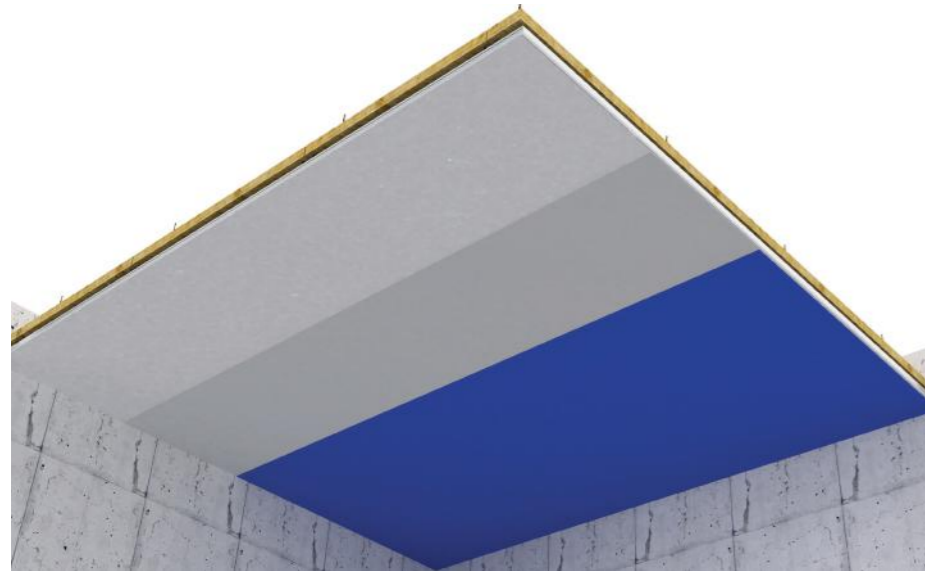

STEP 14

After the plaster is set, surface of the plasterboard is finished by applying primer and paint. Application is completed.

If auxiliary profile range is 400 mm,

CARRELAGE LOAD CARRYING VALUES FOR 0,45 MM CONSTRUCTION

	0,45 mm	Suspension Rod Spacing (a)			
		Load Amount (kg/m ²)			
		≤ 15	≤ 30	≤ 45	≤ 60
Main Profile Spacing (L)	600 mm	1200	1050	900	750
	700 mm	1150	1000	850	700
	800 mm	1100	950	800	650
	900 mm	1050	900	750	-
	1000 mm	1000	850	700	-
	1100 mm	950	800	-	-
	1200 mm	900	750	-	-

Carrelage Load Carrying Values (kg/m²) for a Construction with Auxiliary Profile Spacing of 400 mm - Screw Spacing of 300 mm - Material Thickness of 0,45 mm

*Values given in the tables are calculated by UMS with reference to AISI S100-2007 and Eurocode 3 Part 1.3.

*Yield strength of the material is taken as 235 N/mm², deflection limit is taken as L/360 in calculations.

*All values given above are calculated with reference to UMS profiles.

*Allowable stresses are also taken into account in drawing up the table.

*All values are calculated on the basis of the fact that plaster boards are screwed to the profiles with a spacing of 300 mm.

*UMS recommends 900 mm and below for suspension rod axial spacings.

CARRELAGE LOAD CARRYING VALUES FOR 0,50 MM CONSTRUCTION

	0,50 mm	Suspension Rod Spacing (a)			
		Load Amount (kg/m ²)			
		≤ 15	≤ 30	≤ 45	≤ 60
Main Profile Spacing (L)	600 mm	1200	1100	950	800
	700 mm	1200	1050	850	750
	800 mm	1150	1000	800	700
	900 mm	1100	950	750	650
	1000 mm	1050	900	700	-
	1100 mm	1000	850	-	-
	1200 mm	950	800	-	-

Carrelage Load Carrying Values (kg/m²) for Construction with Auxiliary Profile Spacing of 400 mm - Screw Spacing of 300 mm - Material Thickness of 0,50 mm

*Values given in the tables are calculated by UMS with reference to AISI S100-2007 and Eurocode 3 Part 1.3.

*Yield strength of the material is taken as 235 N/mm², deflection limit is taken as L/360 in calculations.

*All values given above are calculated with reference to UMS profiles.

*Allowable stresses are also taken into account in drawing up the table.

*All values are calculated on the basis of the fact that plaster boards are screwed to the profiles with a spacing of 300 mm.

*UMS recommends 900 mm and below for suspension rod axial spacings.

CARRELAGE LOAD CARRYING VALUES FOR 0,60 MM CONSTRUCTION

0,60 mm		Suspension Rod Spacing (a)			
		Load Amount (kg/m ²)			
		≤ 15	≤ 30	≤ 45	≤ 60
Main Profile Spacing (L)	600 mm	1200	1150	1000	850
	700 mm	1150	1100	900	800
	800 mm	1100	1050	850	750
	900 mm	1050	1000	800	700
	1000 mm	1000	950	750	-
	1100 mm	950	900	-	-
	1200 mm	900	850	-	-

Carrelage Load Carrying Values (kg/m²) for Construction with Auxiliary Profile Spacing of 400 mm - Screw Spacing of 300 mm - Material Thickness of 0,60 mm

- *Values given in the tables are calculated by UMS with reference to AISI S100-2007 and Eurocode 3 Part 1.3.
- *Yield strength of the material is taken as 235 N/mm², deflection limit is taken as L/360 in calculations.
- *All values given above are calculated with reference to UMS profiles.
- *Allowable stresses are also taken into account in drawing up the table.
- *All values are calculated on the basis of the fact that plaster boards are screwed to the profiles with a spacing of 300 mm.
- *UMS recommends 900 mm and below for suspension rod axial spacings.

If auxiliary profile spacing is 500 mm,

CARRELAGE LOAD CARRYING VALUES FOR 0,45 MM CONSTRUCTION

0,45 mm		Suspension Rod Spacing (a)			
		Load Amount (kg/m ²)			
		≤ 15	≤ 30	≤ 45	≤ 60
Main Profile Spacing (L)	600 mm	1200	1050	900	750
	700 mm	1150	1000	850	700
	800 mm	1100	950	800	650
	900 mm	1050	900	750	-
	1000 mm	1000	850	700	-
	1100 mm	950	800	-	-
	1200 mm	900	750	-	-

Carrelage Load Carrying Values (kg/m²) for Construction with Auxiliary Profile Spacing of 500 mm - Screw Spacing of 300 mm - Material Thickness of 0,45 mm

- *Values given in the tables are calculated by UMS with reference to AISI S100-2007 and Eurocode 3 Part 1.3.
- *Yield strength of the material is taken as 235 N/mm², deflection limit is taken as L/360 in calculations.
- *All values given above are calculated with reference to UMS profiles.
- *Allowable stresses are also taken into account in drawing up the table.
- *All values are calculated on the basis of the fact that plaster boards are screwed to the profiles with a spacing of 300 mm.
- *UMS recommends 900 mm and below for suspension rod axial spacings.

CARRELAGE LOAD CARRYING VALUES FOR 0,50 MM CONSTRUCTION

0,50 mm		Suspension Rod Spacing (a)			
		Load Amount (kg/m ²)			
		≤ 15	≤ 30	≤ 45	≤ 60
Main Profile Spacing (L)	600 mm	1200	1100	950	800
	700 mm	1200	1050	850	750
	800 mm	1150	1000	800	700
	900 mm	1100	950	750	650
	1000 mm	1050	900	700	-
	1100 mm	1000	850	-	-
	1200 mm	950	800	-	-

Carrelage Load Carrying Values (kg/m²) for Construction with Auxiliary Profile Spacing of 500 mm - Screw Spacing of 300 mm - Material Thickness of 0,60 mm

- *Values given in the tables are calculated by UMS with reference to AISI S100-2007 and Eurocode 3 Part 1.3.
- *Yield strength of the material is taken as 235 N/mm², deflection limit is taken as L/360 in calculations.
- *All values given above are calculated with reference to UMS profiles.
- *Allowable stresses are also taken into account in drawing up the table.
- *All values are calculated on the basis of the fact that plaster boards are screwed to the profiles with a spacing of 300 mm.
- *UMS recommends 900 mm and below for suspension rod axial spacings.

CARRELAGE LOAD CARRYING VALUES FOR 0,60 MM CONSTRUCTION

0,60 mm		Suspension Rod Spacing (a)			
		Load Amount (kg/m ²)			
		≤ 15	≤ 30	≤ 45	≤ 60
Main Profile Spacing (L)	600 mm	1200	1150	1000	850
	700 mm	1200	1100	900	800
	800 mm	1200	1050	850	750
	900 mm	1150	1000	800	700
	1000 mm	1100	950	750	-
	1100 mm	1050	900	-	-
	1200 mm	1000	850	-	-

Carrelage Load Carrying Values (kg/m²) for Construction with Auxiliary Profile Spacing of 500 mm - Screw Spacing of 300 mm - Material Thickness of 0,60 mm

- *Values given in the tables are calculated by UMS with reference to AISI S100-2007 and Eurocode 3 Part 1.3.
- *Yield strength of the material is taken as 235 N/mm², deflection limit is taken as L/360 in calculations.
- *All values given above are calculated with reference to UMS profiles.
- *Allowable stresses are also taken into account in drawing up the table.
- *All values are calculated on the basis of the fact that plaster boards are screwed to the profiles with a spacing of 300 mm.
- *UMS recommends 900 mm and below for suspension rod axial spacings.

APPLICATION TYPES

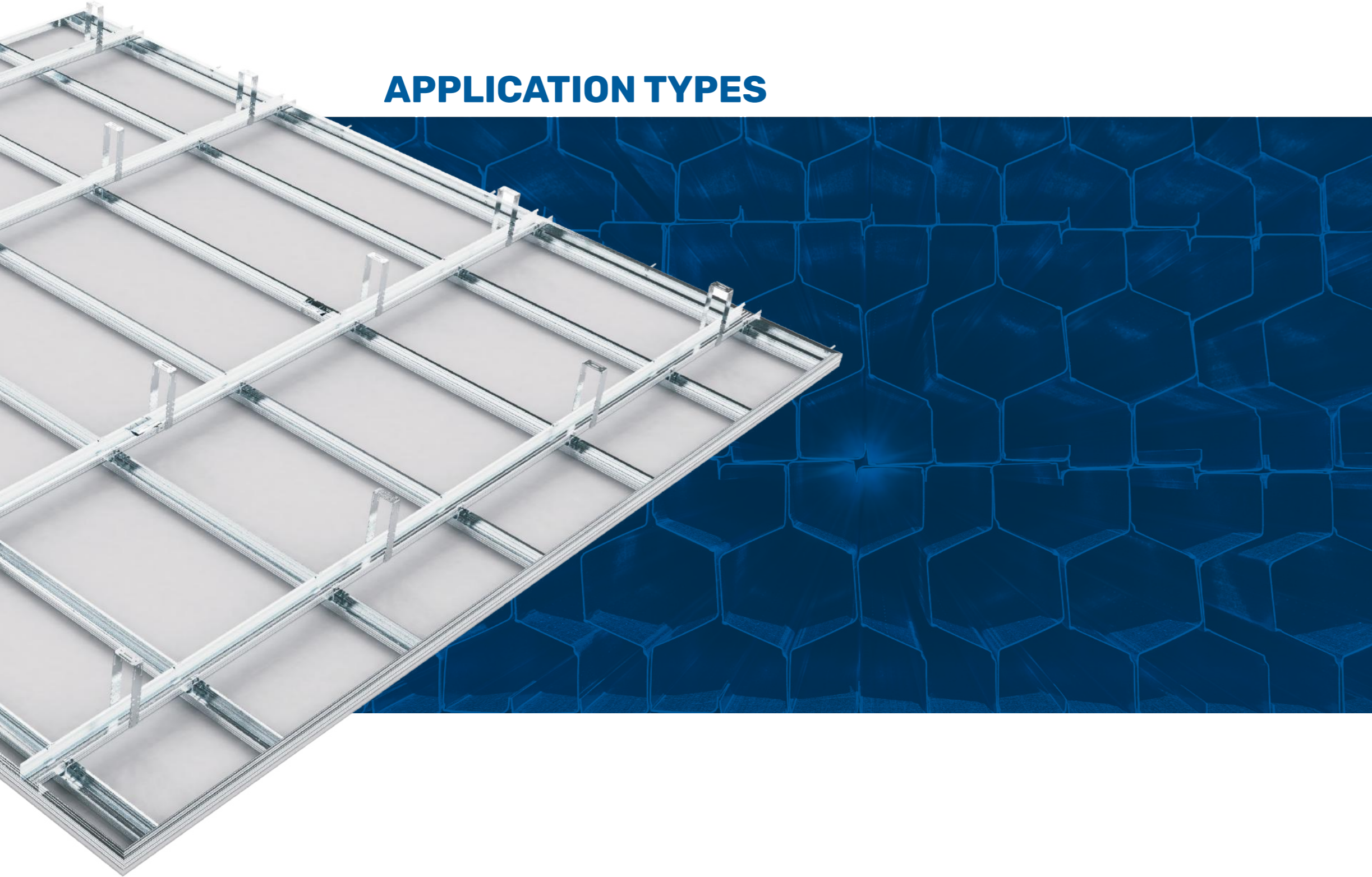

APPLICATION OF SUSPENDED CEILING WITH BRACKET

It is a ceiling system consisting of bracket, clip, Ceiling U, Ceiling C Profiles and plasterboards mounted on these profiles. Ceiling C Profiles are divided into two as main carrier profile and auxiliary carrier profile. Ceiling C profile which is mounted on brackets connected to the ceiling is called main carrier profile while Ceiling C profile which provides a surface for fastening plasterboards is called auxiliary carrier profile. Ceiling U profile is intended to provide guidance for main carrier Ceiling C profiles and form a framework for auxiliary carrier C profiles.

APPLICATION

UMS has specified limit values to be taken into consideration for application of suspended ceiling with bracket in the table on the next page. Material analysis table given on the next page can be utilized for the quantity of materials to be consumed.

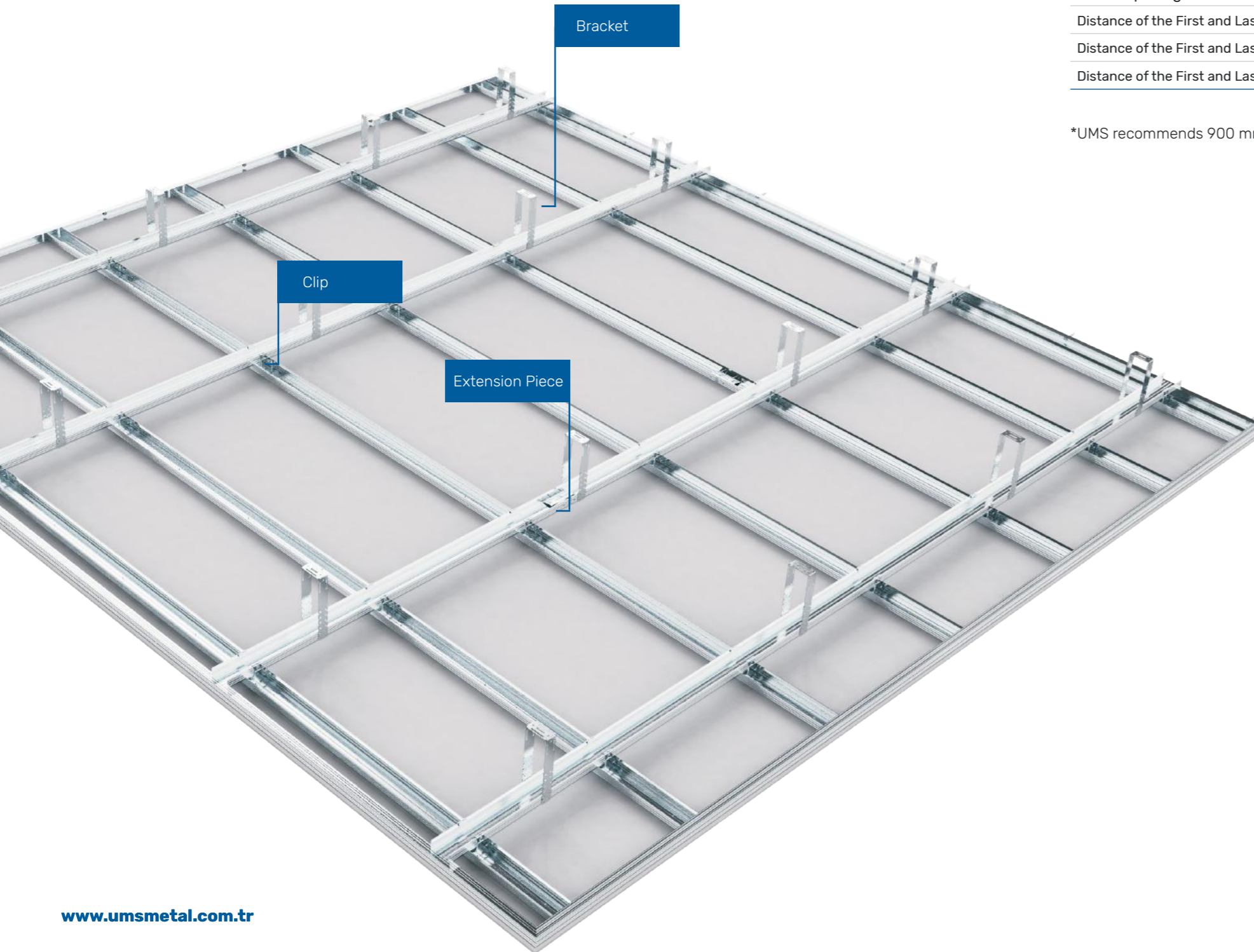

For proper application,

LIMIT VALUES FOR SUSPENDED CEILING WITH BRACKET

DESCRIPTION	LIMIT VALUE
Profile Size:	27/60/27 mm (Main and Auxiliary Carrier Ceiling C Profile)
Main Carrier Profile Range:	must be maximum 1100 mm
Bracket Spacing:	must be maximum 900 mm
Auxiliary Carrier Profile Spacing:	must be maximum 500 mm
Screw Spacing:	must be maximum 300 mm
Distance of the First and Last Main Carrier Profile to the Parallel Wall:	must be maximum 150 mm
Distance of the First and Last Auxiliary Carrier Profile to the Parallel Wall:	must be maximum 100 mm
Distance of the First and Last Brackets to Perpendicular Walls:	must be maximum 250 mm

*UMS recommends 900 mm and lower measures for bracket axial spacings.

MATERIAL ANALYSIS FOR SUSPENDED CEILING WITH BRACKET

DESCRIPTION	1 m ² CONSUMPTION
Plasterboard:	1,05 m ²
Ceiling C Profile:	3,6 m
Ceiling U Profile:	1,3 m
Bracket:	1,7 pcs
Bracket:	5,8 pcs
Extension Piece:	0,7 pcs
Joint Tape:	1,8 m
Drywall Screw:	16 pcs
Steel Wall Plug:	1,7 pcs
Plastic Wall Plug, Shim, Screw:	1 pcs
Jointing Plaster:	0,4 kg
Satin Finishing Plaster:	1 kg/ m ²
Insulating Tape:	1,3 m
Insulating Material (Optional):	1,05 m ²
Corner Profile (Corner Tape):	According to technical details of the ceiling

*Consumptions may vary depending on project details.

Order of operations given below should be followed for a complete application.

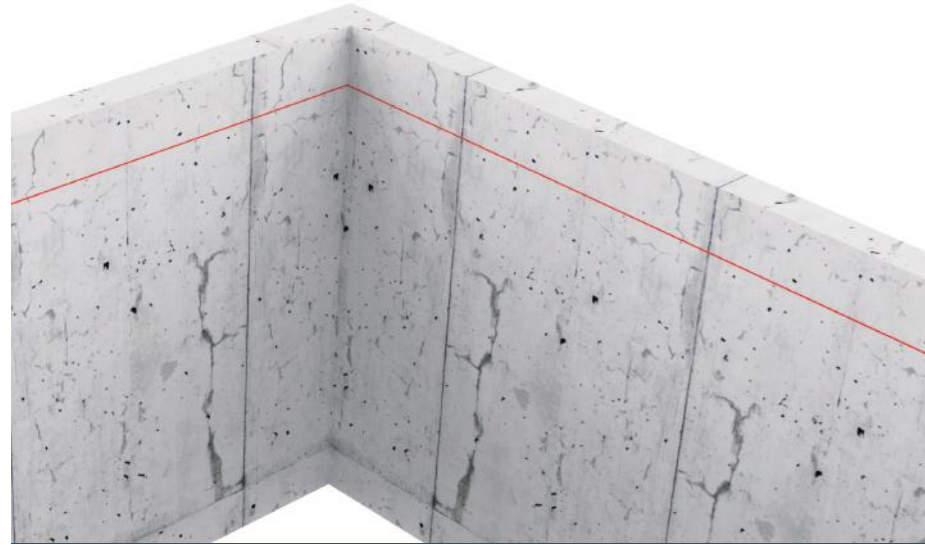

STEP 1

Suspended ceiling elevation is determined using auxiliary equipment including laser, chalk line, water balance etc.



STEP 2

Ceiling U profiles, in accordance with suspended ceiling elevation, are fixed onto the walls using suitable wall plugs and screws, with a distance of 50 mm from both ends, with a spacing of 600 mm, as insulating tape applied to the parts that touch the wall.

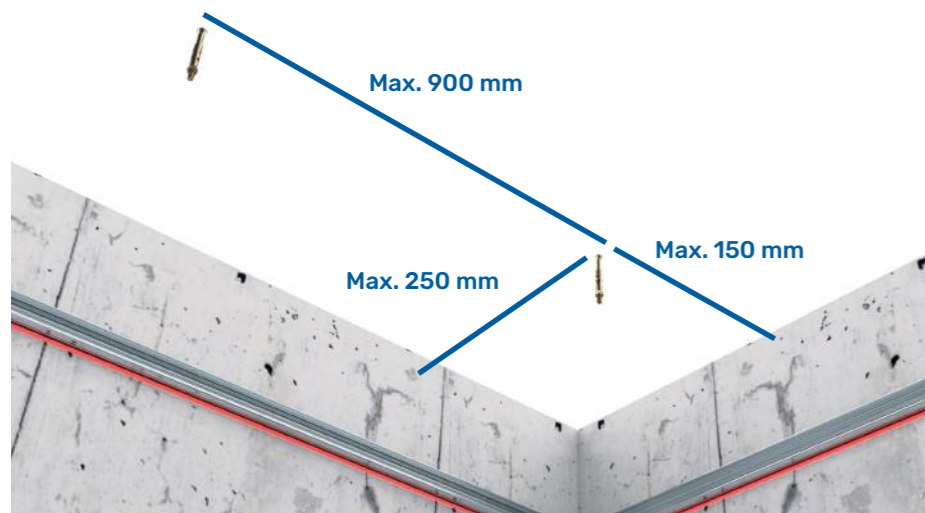

STEP 3

Position of steel wall plugs is determined so that main carrier Ceiling C profile is maximum 150 mm to the parallel walls, maximum 250 mm to the perpendicular walls and spacing between each bracket is maximum 900 mm. Set steel wall plug positions are drilled and wall plugs are mounted.

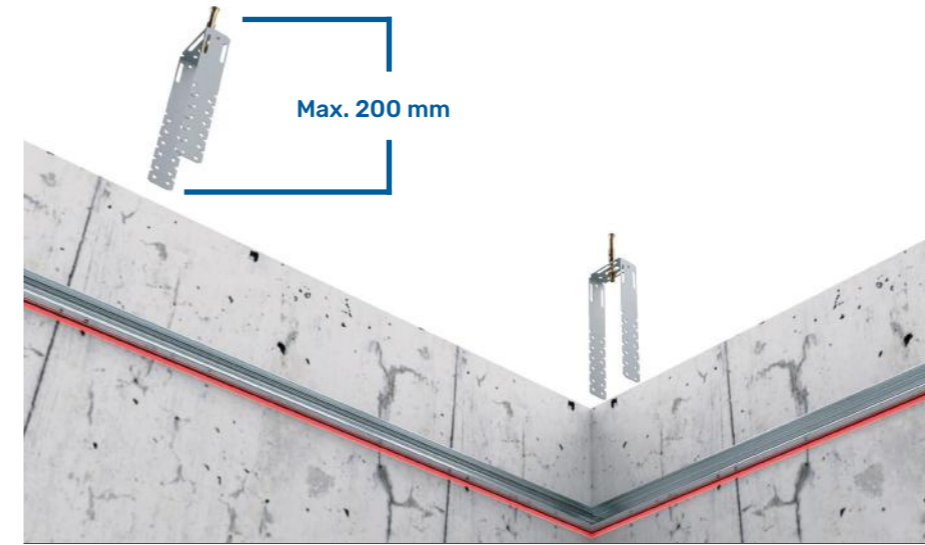

STEP 4

Brackets are cut in accordance with the project so that they do not exceed 200 mm in length and mounting is completed by pinning them into the existing wall plugs with nuts. If the length of bracket exceeds main carrier Ceiling C profile, exceeding part is folded and leveled with main carrier Ceiling C profile.



STEP 5

Main carrier Ceiling C profiles are positioned so that they are placed on Ceiling U profiles and do not touch the wall, and they are screwed and fastened to brackets on both sides.

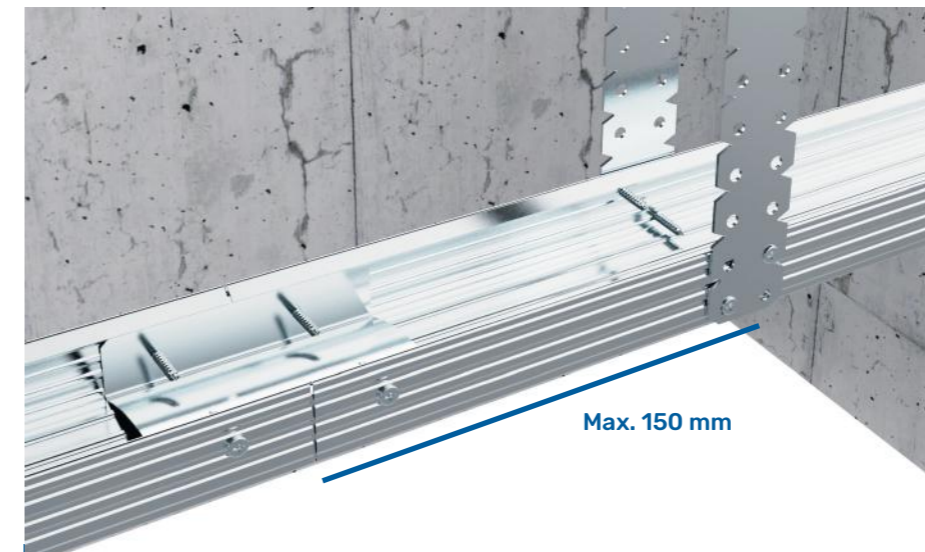

STEP 6

In case the length of Main Carrier Ceiling C Profile is shorter than application distance, two Ceiling C Profiles are attached using extension piece. Places of extension piece should be set so as to be maximum 150 mm to the bracket.

Order of operations given below should be followed for a complete application.

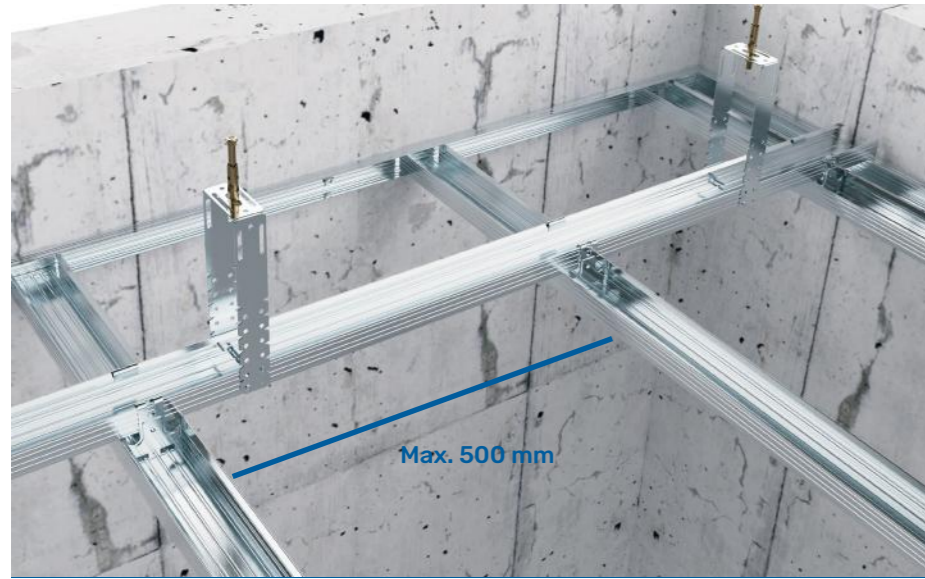

STEP 7

Auxiliary Carrier Ceiling C Profiles are fastened to Main Carrier Ceiling C Profiles using clips, with a distance of maximum 500 mm to each other.

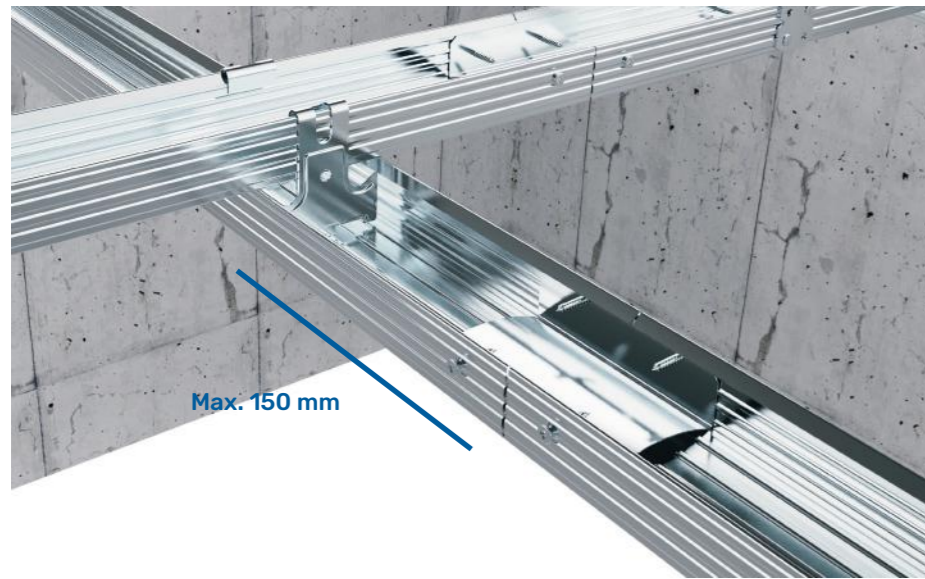

STEP 8

For lengths where a single part cannot pass through at joining points of Auxiliary Carrier Ceiling C profiles, channel connectors are used. Channel connectors are fixed to both profiles with metal-metal screws and aligned zigzag in parallel profiles. Place of channel connectors should be maximum 150 mm from the clips.

Suspended ceiling system with bracket is completed.



STEP 9

Insulating materials are placed on profiles in accordance with the project.

*Following steps are written with reference to plaster board application. Order and content of steps may vary when different materials are used.

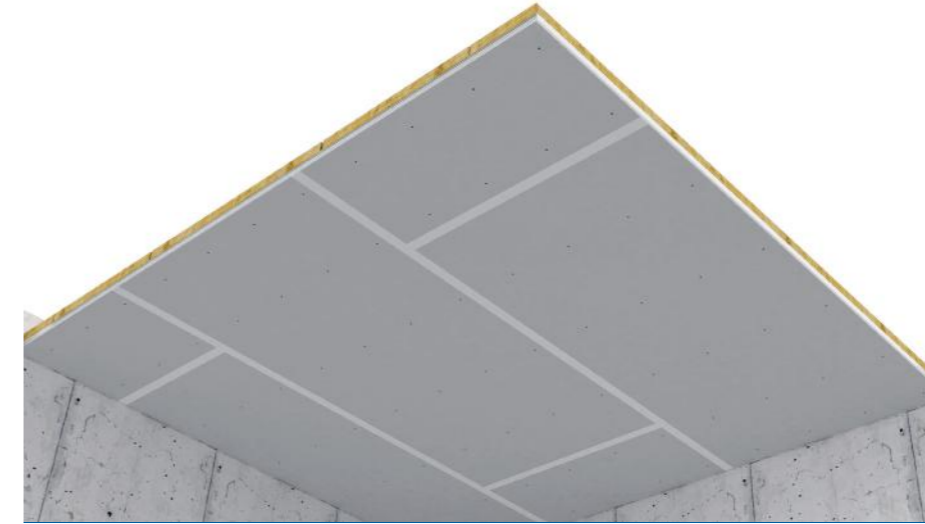

STEP 10

Plaster boards are cut according to the project. Cut plaster boards are mounted onto Auxiliary Carrier Ceiling C profiles in a zigzag way, with suitable screws and spaces between screws. Plaster board joints are covered using joint tapes of appropriate thickness and width according to the project.

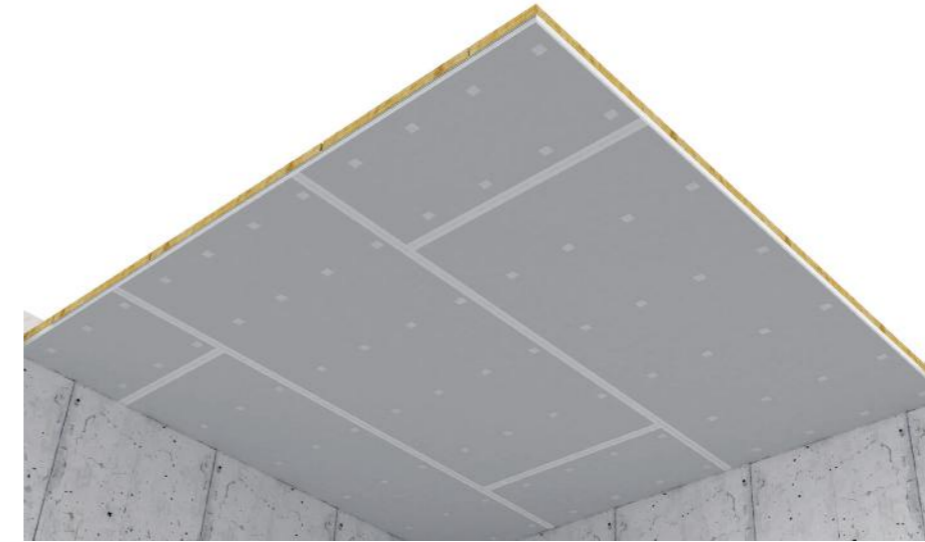

STEP 11

Covered joints and screw heads are filled with suitable jointing plaster, after the filling plaster dries out, treatment area is sandpapered and leveled with the board.

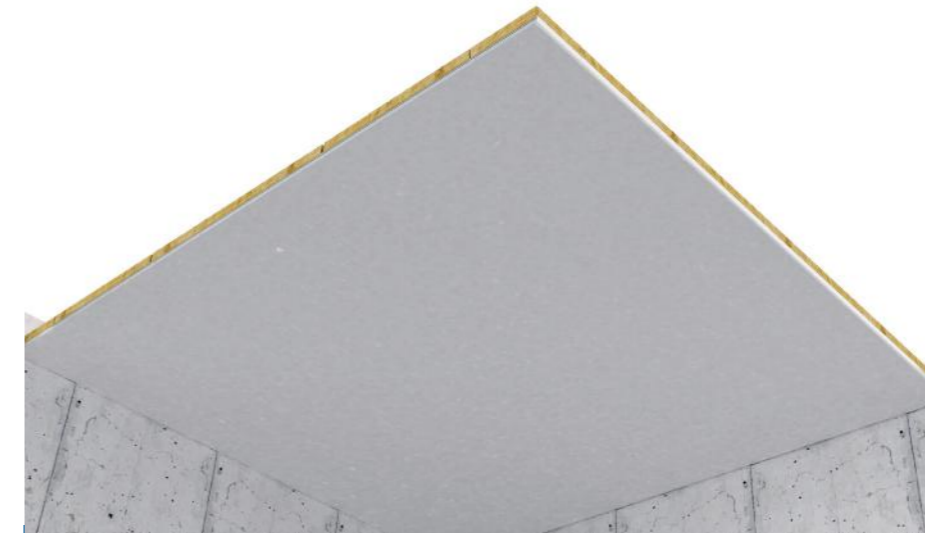

STEP 12

Satin plaster is applied, the surface is sandpapered.

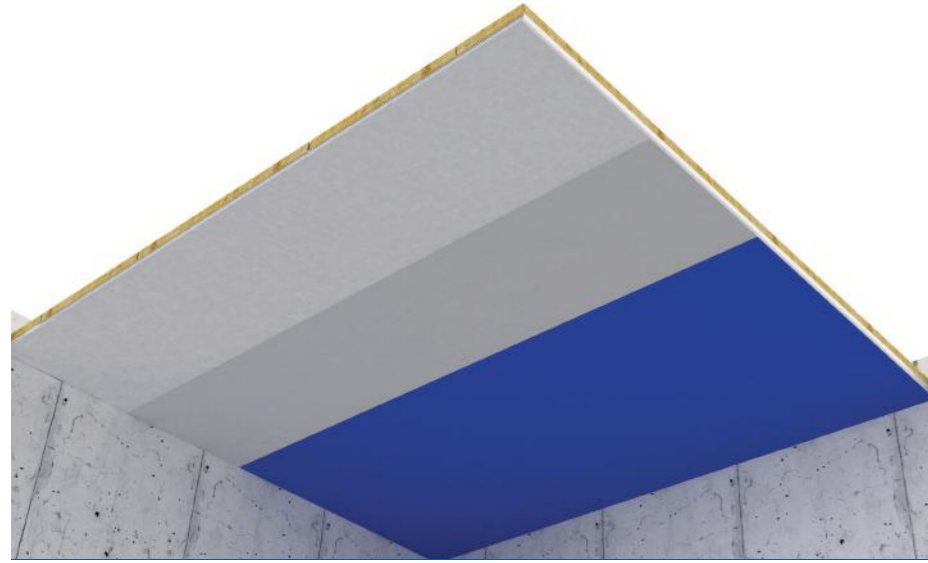

STEP 13

After the plaster is set, surface of the plasterboard is finished by applying primer and paint. Application is completed.



APPLICATION TYPES

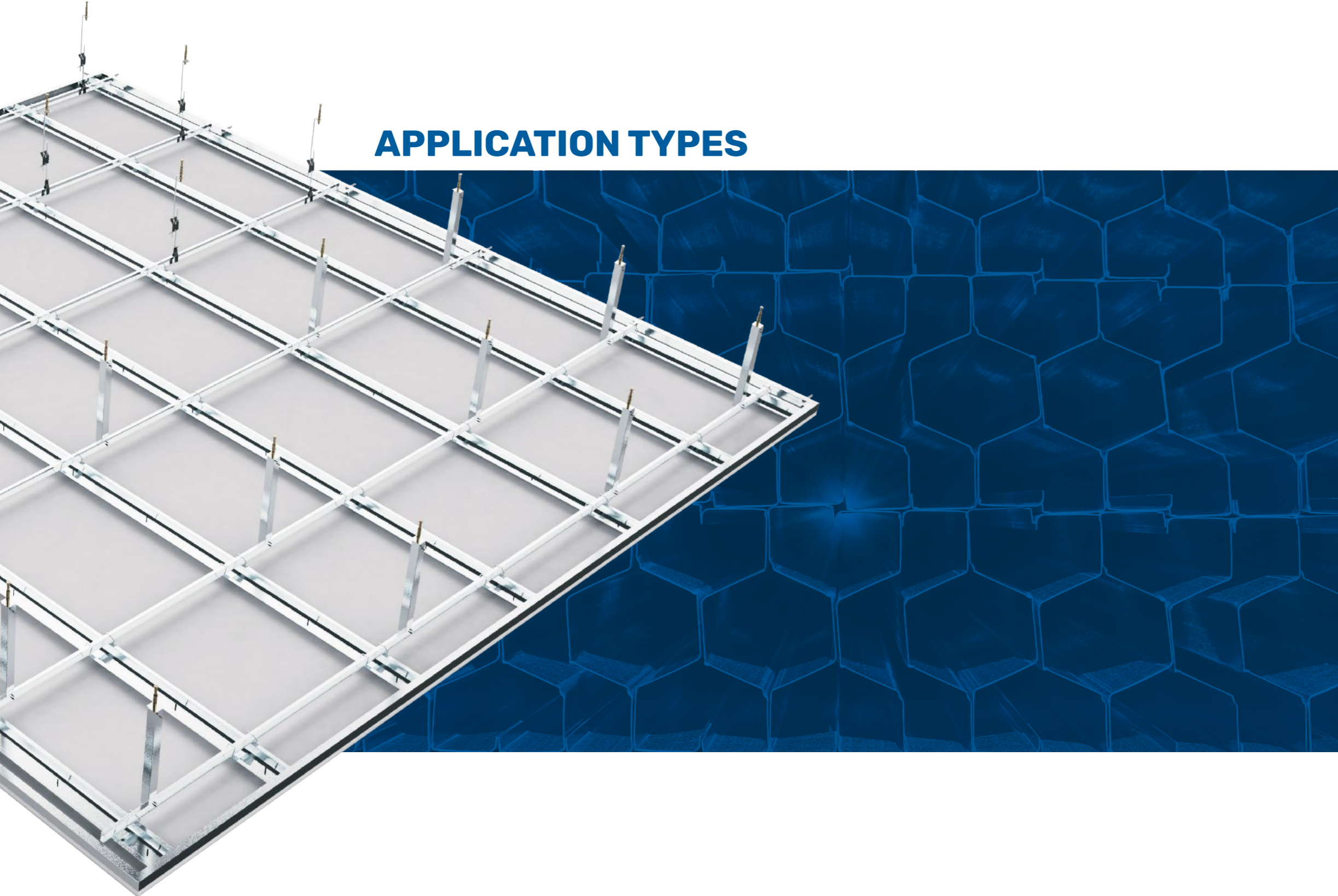

OMEGA PROFILE SUSPENDED CEILING APPLICATION

It is a ceiling system consisting of auxiliary components like hanger clip, suspension rod, clip, and Main Carrier Ceiling U, Auxiliary Carrier Omega Profiles and plasterboards mounted on these profiles. It is formed by fastening Auxiliary Carrier Omega Profiles with clips on two sides to Ceiling U profiles which are directly fastened to suspension rod and hanger clip. Auxiliary Carrier Omega Profiles form a surface for mounting plaster boards.

APPLICATION

UMS has specified limit values to be taken into consideration for application of omega profile suspended ceiling in the table on the next page. Material analysis table given on the next page can be utilized for the quantity of materials to be consumed.

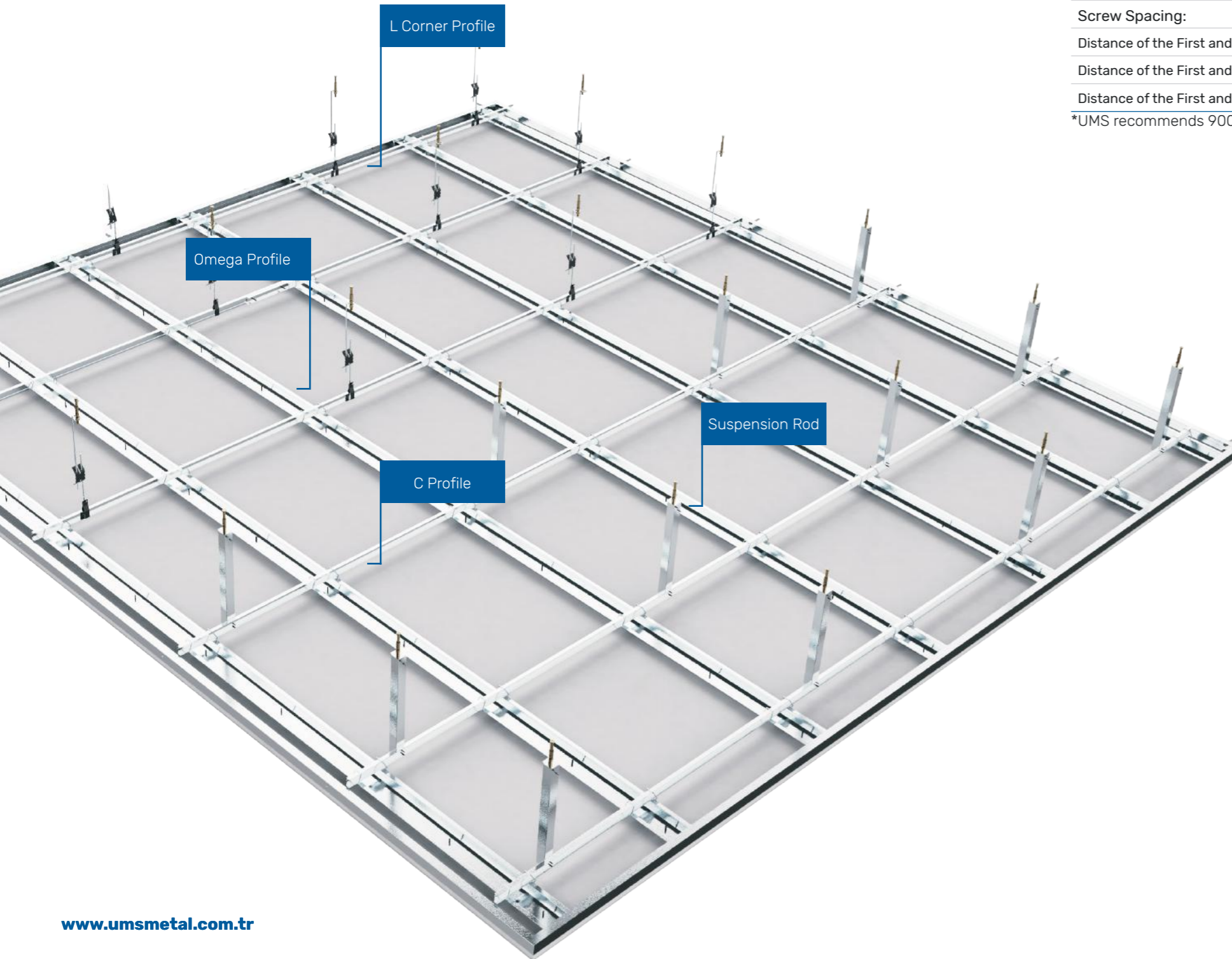

For proper application,

LIMIT VALUES FOR OMEGA PROFILE SUSPENDED CEILING

DESCRIPTION	LIMIT VALUE
Profile Size:	22/68/22 mm – 22/83/22 mm (Auxiliary Carrier Ceiling Omega Profile)
Main Carrier Profile Range:	must be maximum 1200 mm
Bracket Spacing:	must be maximum 1100 mm
Auxiliary Carrier Profile Spacing:	must be maximum 500 mm
Screw Spacing:	must be maximum 300 mm
Distance of the First and Last Main Carrier Profile to the Parallel Wall:	must be maximum 150 mm
Distance of the First and Last Auxiliary Carrier Profile to the Parallel Wall:	must be maximum 100 mm
Distance of the First and Last Brackets to Perpendicular Walls:	must be maximum 250 mm

*UMS recommends 900 mm and below for suspension rod axial spacings.

MATERIAL ANALYSIS FOR OMEGA PROFILE SUSPENDED CEILING

DESCRIPTION	1 m ² CONSUMPTION
Plasterboard:	1,05 m ²
Carrier U Profile:	2,2 m
Omega Profile:	2,4 m
Ceiling U Profile:	1,3 m
Hooked Wire Hanger*:	2,9 pcs
Suspension Rod*:	2,9 pcs
Suspension Clip*:	2,9 pcs
Double Spring*:	2,9 pcs
Joint Tape:	1,8 m
Drywall Screw:	16 pcs
Steel Wall Plug:	2,9 pcs
Plastic Wall Plug, Shim, Screw:	1 pcs
Jointing Plaster:	0,4 kg
Satin Finishing Plaster:	1 kg/ m ²
Insulating Tape:	1,3 m
Insulating Material (Optional):	1,05 m ²
Corner Profile (Corner Tape):	According to technical details of the ceiling

*Consumptions may vary depending on project details.

Order of operations given below should be followed for a complete application.



STEP 1

Suspended ceiling elevation is determined using auxiliary equipment including laser, chalk line, water balance etc.



STEP 2

U profiles, in accordance with suspended ceiling elevation, are fixed onto the walls using suitable wall plugs and screws, with a distance of 50 mm from both ends, with a spacing of 600 mm, as insulating tape applied to the parts that touch the wall.

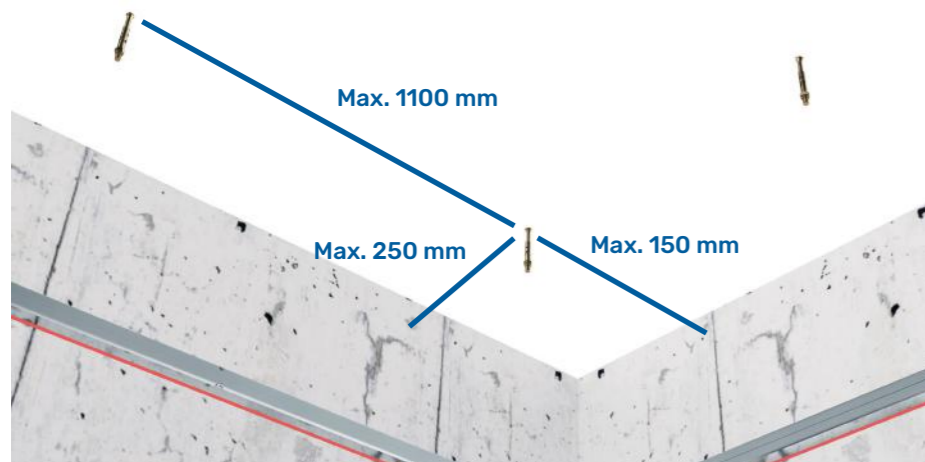

STEP 3

Position of steel wall plugs is determined so that main carrier U profile is maximum 150 mm to the parallel walls, maximum 250 mm to the perpendicular walls and each suspension rod or L profile spacing is maximum 1100 mm. Set steel wall plug positions are drilled and wall plugs are mounted.

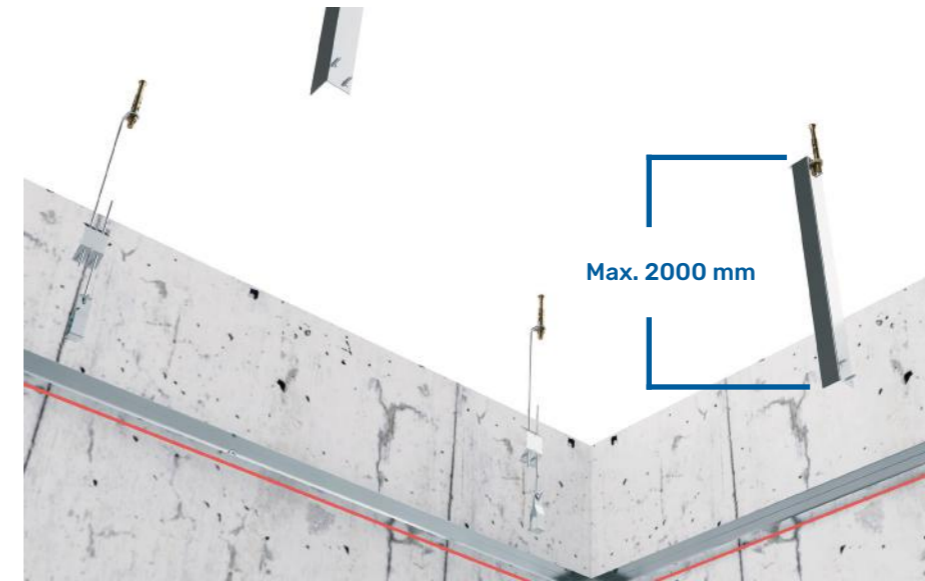

STEP 4

Suspension rod or L profile is cut in accordance with the project so that they do not exceed 2000 mm in length and mounting is completed by pinning them into the existing wall plugs with nuts. When mounting L profile, L brackets attached to steel wall plug are used. L profiles are fastened to L brackets with metal-to-metal screw. In using suspension rod, carrier clips are fastened to suspension rod with double spring accessory. Height is adjusted by means of double spring in accordance with ceiling elevation.

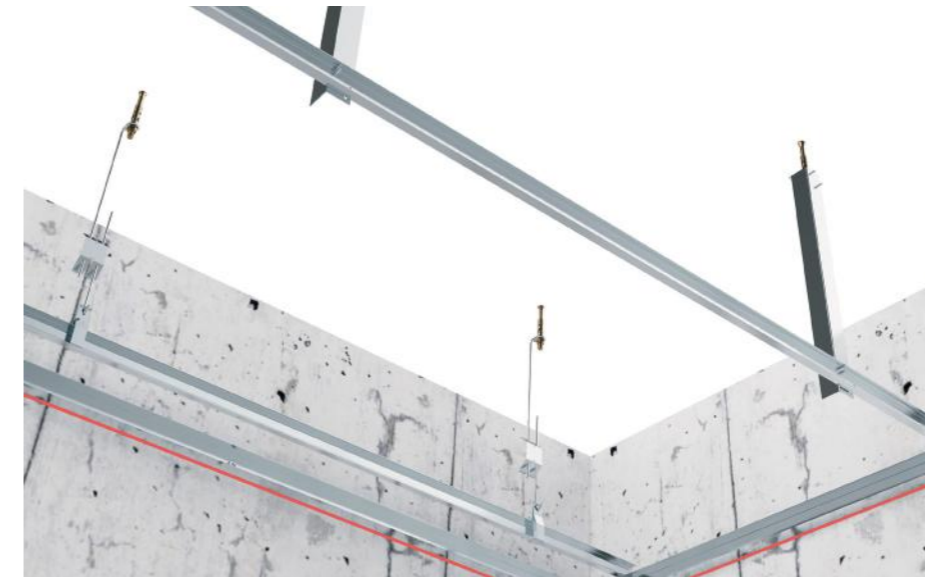

STEP 5

Main carrier Ceiling U profiles are positioned so as to be over the horizontal Ceiling U profiles that serve as a guide and not to touch the wall, and they are mounted in the following ways; if suspension rod is used, they are slipped on carrying clips, if L profile is used they are screwed to the U profile on two points. Main carrier Ceiling U profile spacings should be formed according to the load to be carried making use of the table at the end of the heading.

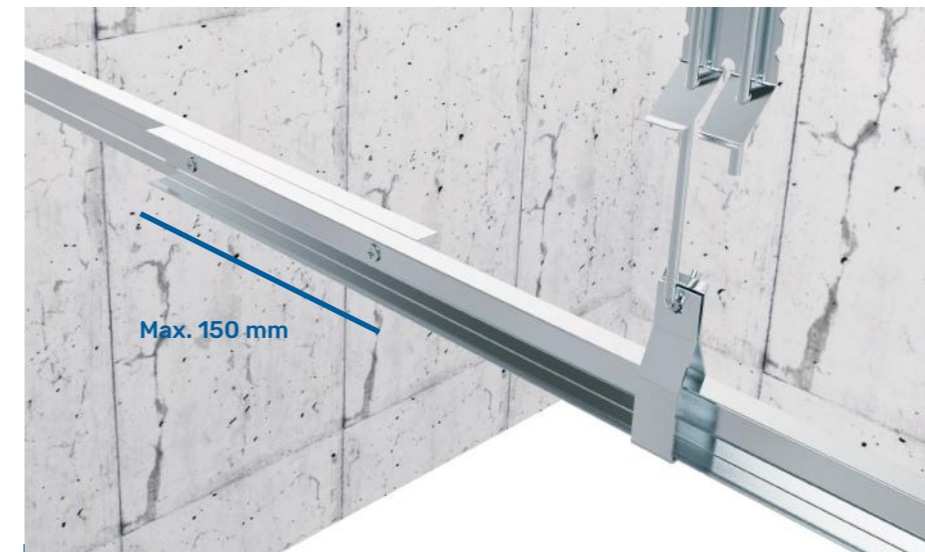

STEP 6

At the joining points of main carrier U profiles, U profiles are aligned back-to-back and screwed so as to lap over each other at least 150 mm.

*If the long side of plaster boards is PERPENDICULAR to auxiliary carrier TC profiles, auxiliary carrier axial spacings should be maximum 500 mm. *If the long side of plaster boards is PARALLEL to auxiliary carrier TC profiles, auxiliary carrier axial spacings should be maximum 400 mm. Effect of auxiliary profile application with 400 mm and 500 mm spacings on main profile spacings based on system weight is shown in the table at the end of the heading.

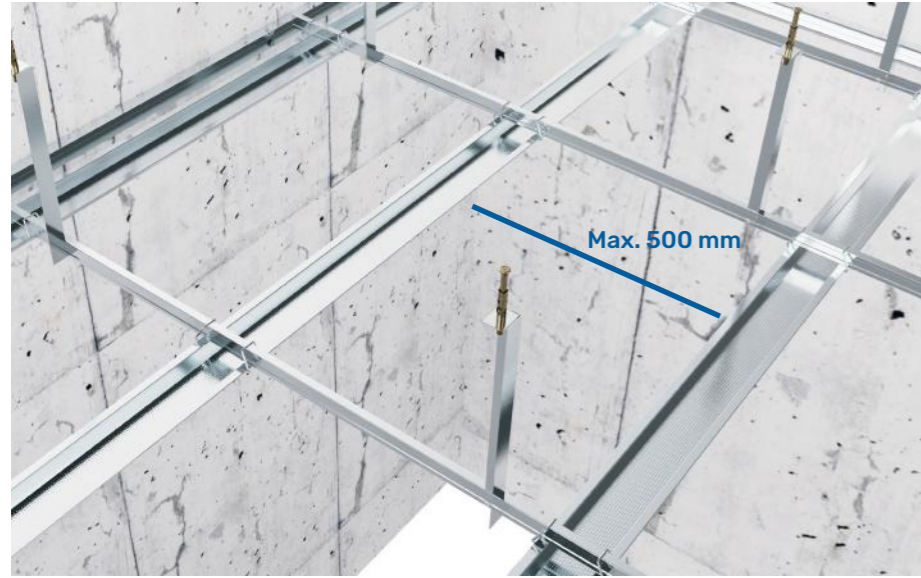

STEP 7

Auxiliary Carrier Omega Profiles are fastened to Carrier U Profiles by means of fastening clip so that spacings between them do not exceed 500 mm.



STEP 8

At the joining points of Auxiliary Carrier Omega Profiles, Auxiliary Carrier Omega Profiles are aligned so as to overlap at least 150 mm and screwed with metal-to-metal screw. Distance between joining points of Main Carrier Ceiling U profiles and Auxiliary Carrier Omega profiles should be minimum 1200 mm.

Omega profile suspended ceiling system is completed.



STEP 9

Insulating materials are placed on profiles in accordance with the project.

*Following steps are written with reference to plaster board application. Order and content of steps may vary when different materials are used.

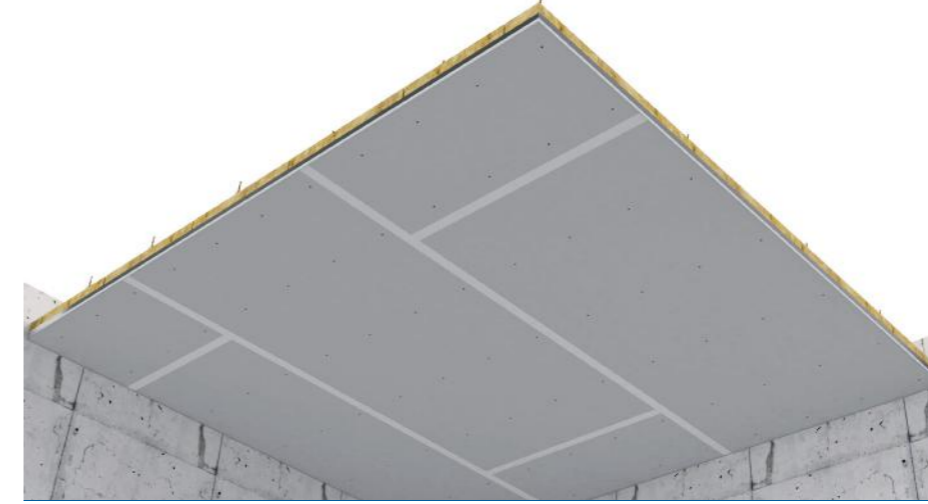

STEP 10

Plaster boards are cut according to the project. Cut plaster boards are mounted onto Auxiliary Carrier Omega profiles in a zigzag way, with suitable screws and screw spacings. Plaster board joints are covered using joint tapes of appropriate thickness and width according to the project.

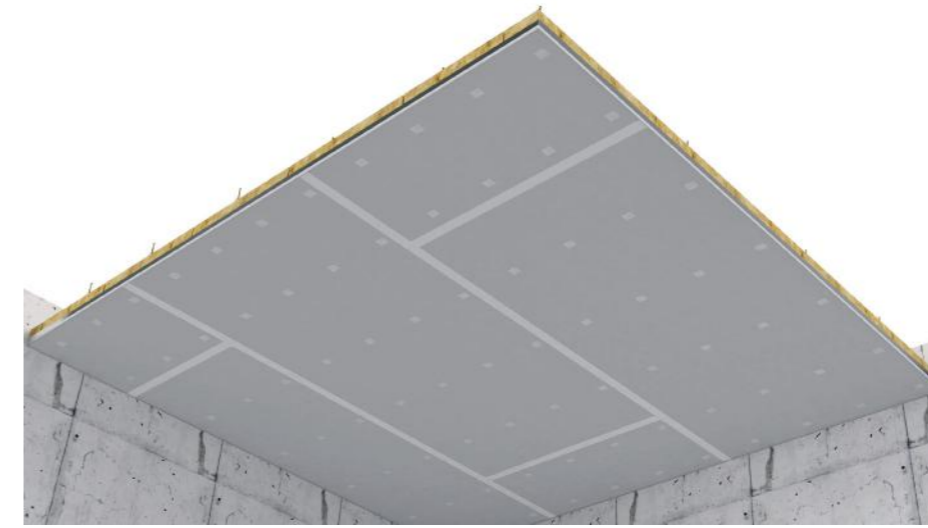

STEP 11

Covered joints and screw heads are filled with suitable jointing plaster, after the plaster dries, treated area is sandpapered and leveled with the board.

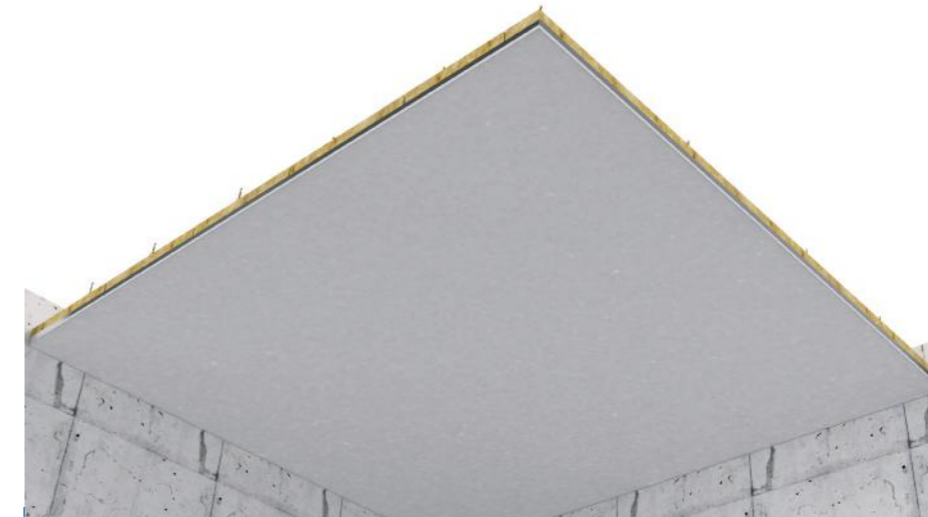

STEP 12

Satin plaster is applied, the surface is sandpapered.

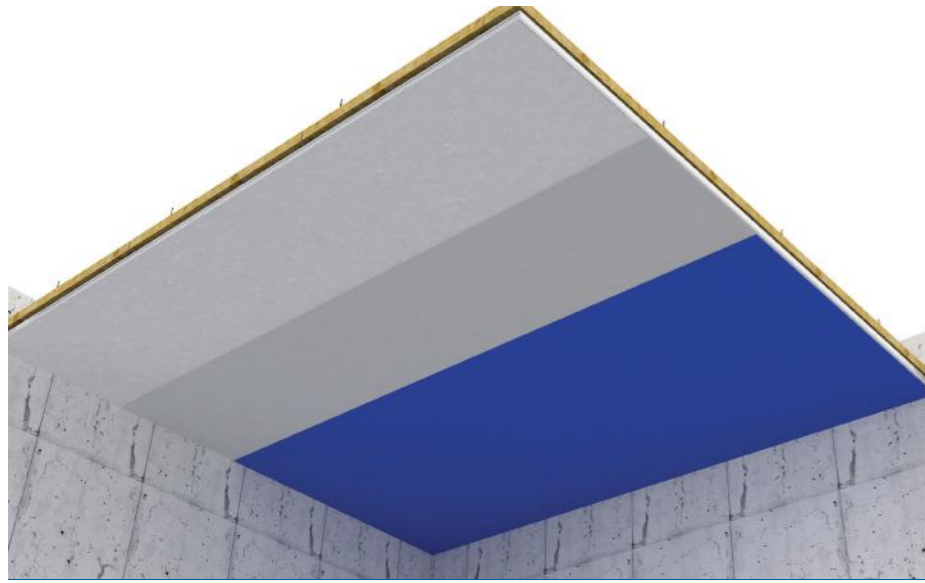

STEP 13

After the plaster is set, surface of the plasterboard is finished by applying primer and paint. Application is completed.

LOAD CARRYING TABLE FOR OMEGA PROFILE SUSPENDED CEILING

MAXIMUM LOAD CARRYING TABLE ACCORDING TO 0,50 MM AUXILIARY CEILING C PROFILE

0,50 mm Main Profile Spacing (m)	Maximum Load Carrying (kg/m ²)	
	For 400 mm Auxiliary Profile	For 500 mm Auxiliary Profile
600	≤ 55	≤ 55
900	≤ 35	≤ 35
1200	≤ 25	≤ 25

*Values given in the tables are calculated by UMS with reference to AISI S100-2007 and Eurocode 3 Part 1.3.

*Yield strength of the material is taken as 235 N/mm², deflection limit is taken as L/360 in calculations.

*All values given above are calculated with reference to UMS profiles.

*Allowable stresses are also taken into account in drawing up the table.

*All values are calculated on the basis of the fact that plaster boards are screwed to the profiles with a spacing of 300 mm.

*UMS recommends 900 mm and below for suspension rod axial spacings.



APPLICATION TYPES

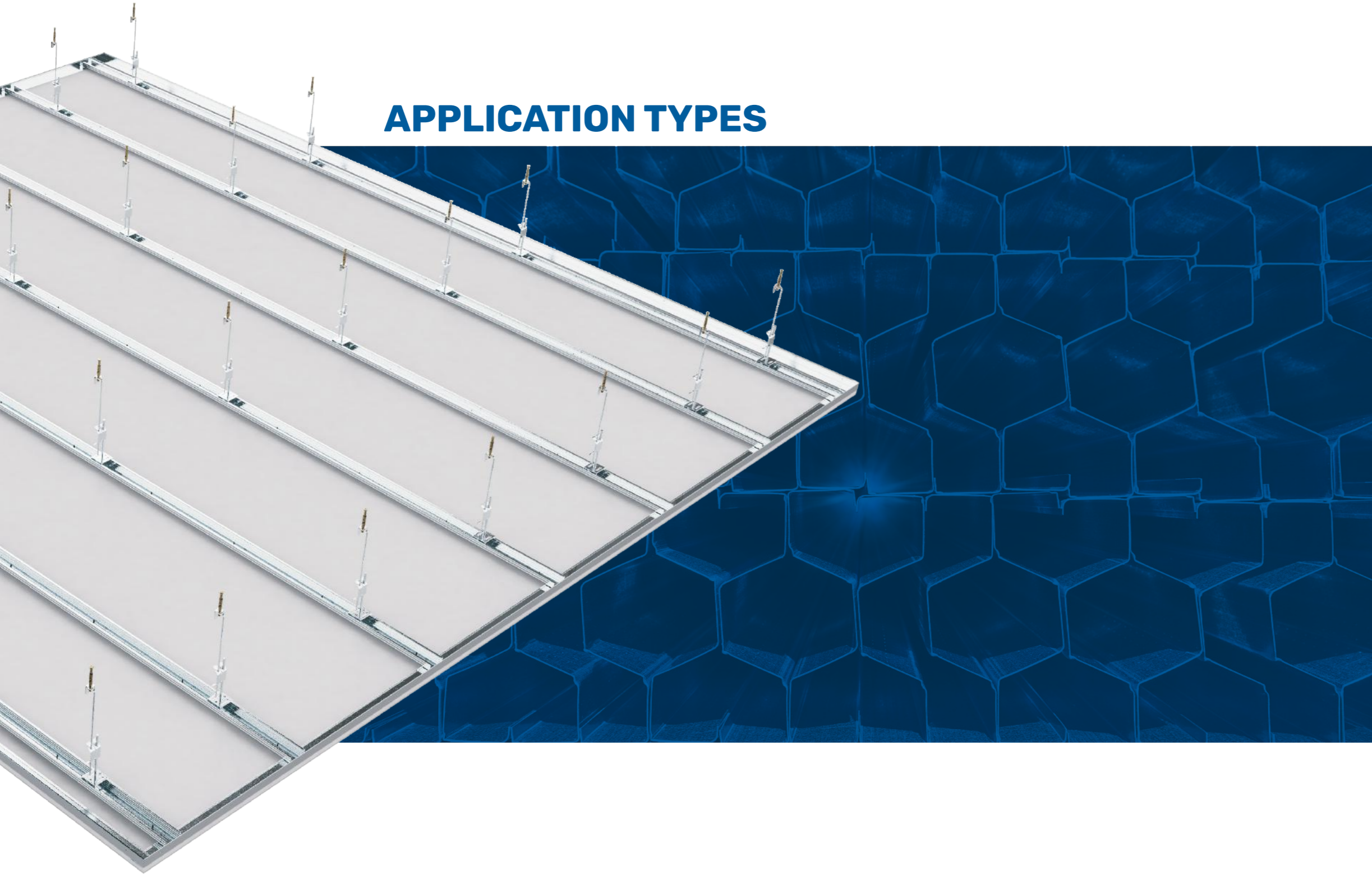

SUSPENDED CEILING APPLICATION WITH CEILING C47 PROFILE

This is a ceiling system consisting of auxiliary components like suspension rod, double spring, quartet clips, and Ceiling C47 profile, L corner profile or Ceiling U profile and plaster boards mounted on these profiles. It is formed by hanging Ceiling C47 profiles on quartet clips which are fastened to suspension rods by means of double spring.

APPLICATION

UMS has specified limit values to be taken into consideration for application of Ceiling C47 profile suspended ceiling in the table on the next page. Material analysis table given on the next page can be utilized for the quantity of materials to be consumed.

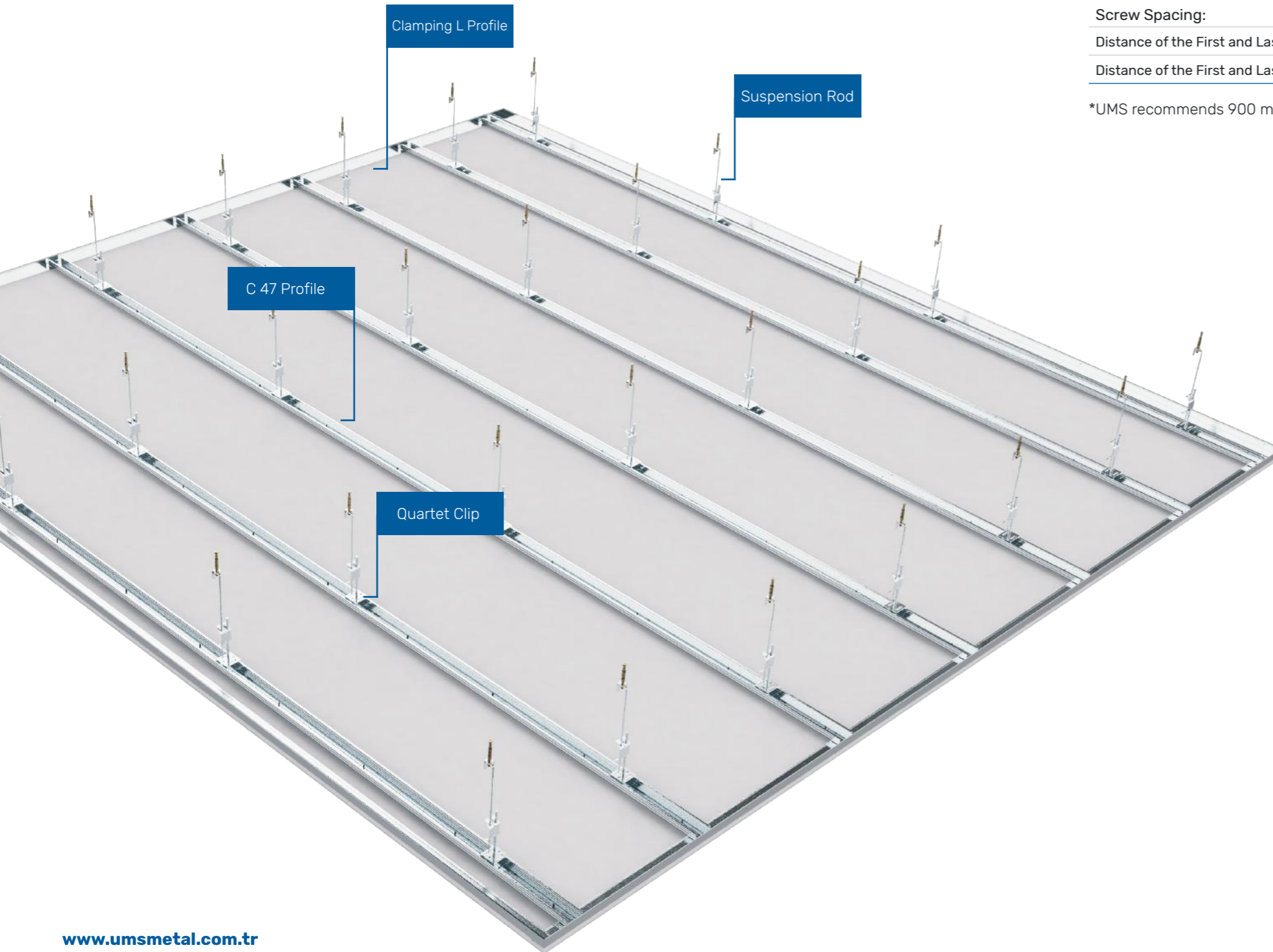

For proper application,

LIMIT VALUES FOR SUSPENDED CEILING WITH CEILING C47 PROFILE

DESCRIPTION	LIMIT VALUE
Profile Size:	18/47/18 mm (Ceiling C47 Profile)
Ceiling C47 Profile Spacing:	must be maximum 500 mm
Suspension Rod Spacing:	must be maximum 1100 mm
Screw Spacing:	must be maximum 300 mm
Distance of the First and Last C47 Profile to the Parallel Wall:	must be maximum 100 mm
Distance of the First and Last Suspension Rods to Perpendicular Walls:	must be maximum 250 mm

*UMS recommends 900 mm and below for suspension rod axial spacings.

MATERIAL ANALYSIS FOR SUSPENDED CEILING WITH CEILING C47 PROFILE

DESCRIPTION	1 m ² CONSUMPTION
Plasterboard:	1,05 m ²
Ceiling C 47 Profile:	2,4 m
Clamping L Profile:	1,3 m
Screwed Wire:	2,9 pcs
Suspension Rod:	2,9 pcs
Special Clip:	2,9 pcs
Double Spring:	2,9 pcs
Extension Piece:	0,7 pcs
Joint Tape:	1,8 m
Drywall Screw:	16 pcs
Steel Wall Plug:	2,9 pcs
Plastic Wall Plug, Shim, Screw:	1 pcs
Jointing Plaster:	0,4 kg
Satin Finishing Plaster:	1 kg/ m ²
Insulating Tape:	1,3 m
Insulating Material (Optional):	1,05 m ²
Corner Profile (Corner Tape):	According to technical details of the ceiling

*Consumptions may vary depending on project details.

Order of operations given below should be followed for a complete application.



STEP 1

Suspended ceiling elevation is determined using auxiliary equipment including laser, chalk line, water balance etc.



STEP 2

L or U profiles, in accordance with suspended ceiling elevation, are fixed onto the walls using suitable wall plugs and screws, with a distance of 50 mm from both ends, with a spacing of 600 mm, as insulating tape applied to the parts that touch the wall.

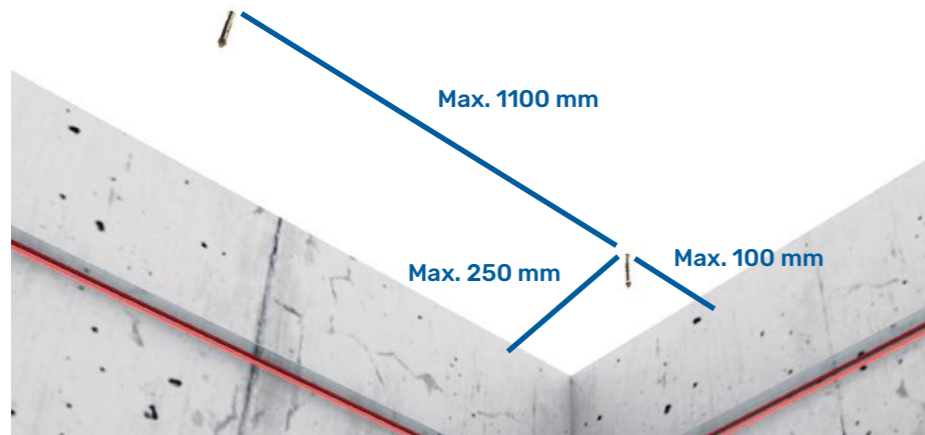

STEP 3

Position of steel wall plugs is set so that Ceiling C47 profile is maximum 100 mm to the parallel walls, maximum 250 mm to the perpendicular walls and each suspension rod spacing is maximum 1100 mm. Set steel wall plug positions are drilled and wall plugs are mounted.

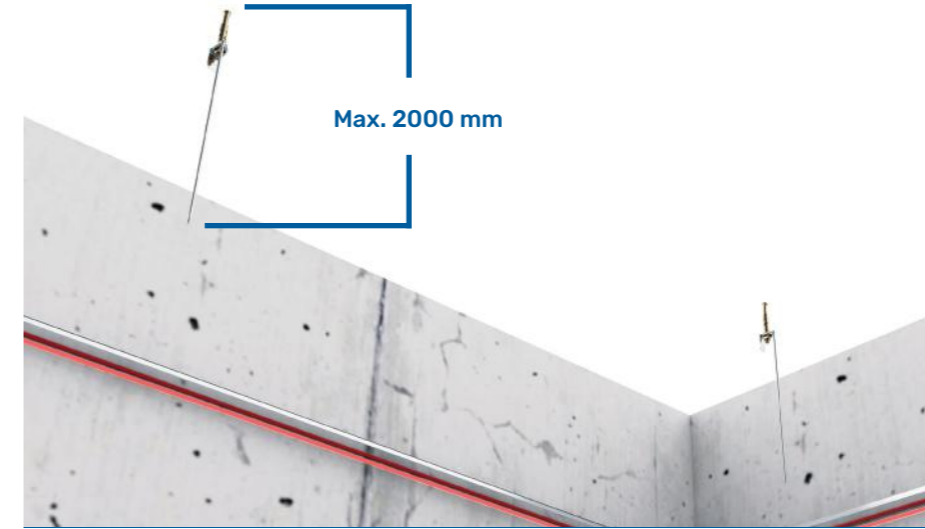

STEP 4

Suspension rods are cut in accordance with the project so that they do not exceed 2000 mm in length and mounting is completed by pinning them into the existing wall plugs with nuts.



STEP 5

Quartet clips are fastened to suspension rod with double spring accessory. Height is adjusted by means of double spring in accordance with ceiling elevation.



STEP 6

Ceiling C47 profiles are positioned so as to be on horizontal Ceiling L or U profiles that serve as guide and they are mounted by hanging on quartet clips fastened to suspension rods. Ceiling C47 profile spacings should be formed based on the load to be carried using the table below.

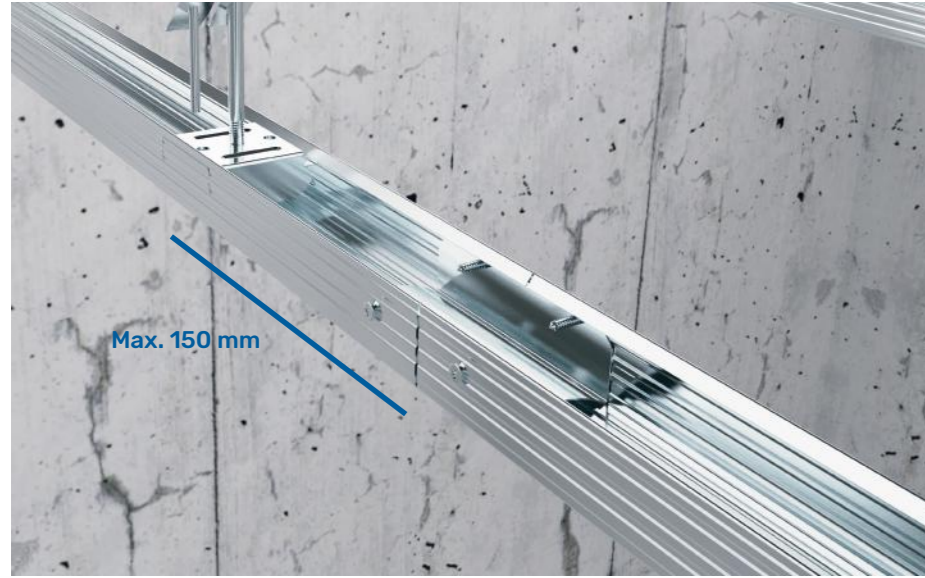

*Ceiling C47 spacings are left as 400 mm and 500 mm. In the tables given at the end of this heading, maximum load carrying capacity of the system according to main profile spacings based on application of suspension rods at various spacings according to profile thickness is specified.

STEP 7

For lengths where a single part cannot pass through at joining points of Ceiling C47 profiles, channel connectors are used. Channel connectors are fixed to both profiles from the sides that touch the profile with drywall screws and aligned zigzag in parallel profiles.

C47 profile suspended ceiling system is completed.



*Following steps are written with reference to plaster board application. Order and content of steps may vary when different materials are used.

STEP 8

Insulating materials are placed on profiles in accordance with the project.

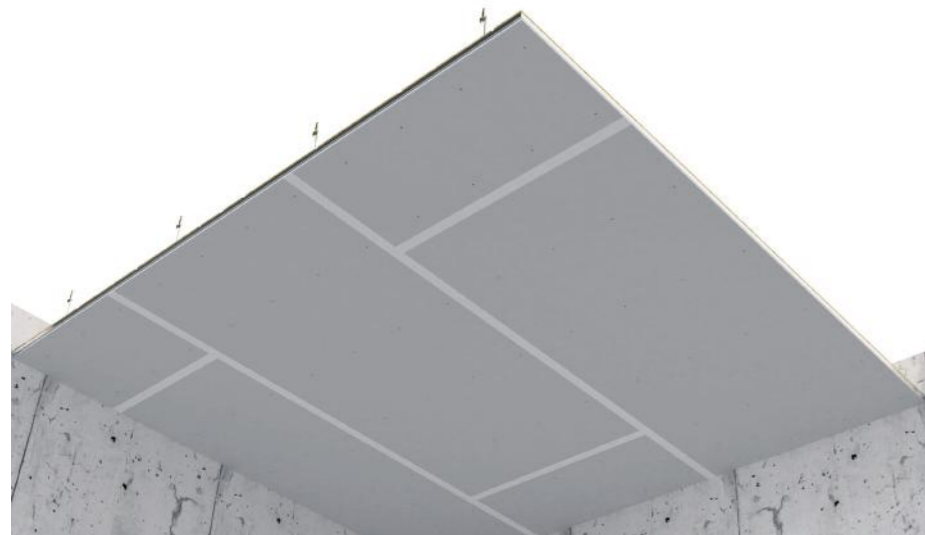

STEP 9

Plaster boards are cut according to the project. Cut plaster boards are mounted onto Ceiling C47 profile in a zigzag way, with suitable screws and screw spacing. Plaster board joints are covered using joint tapes of appropriate thickness and width according to the project.

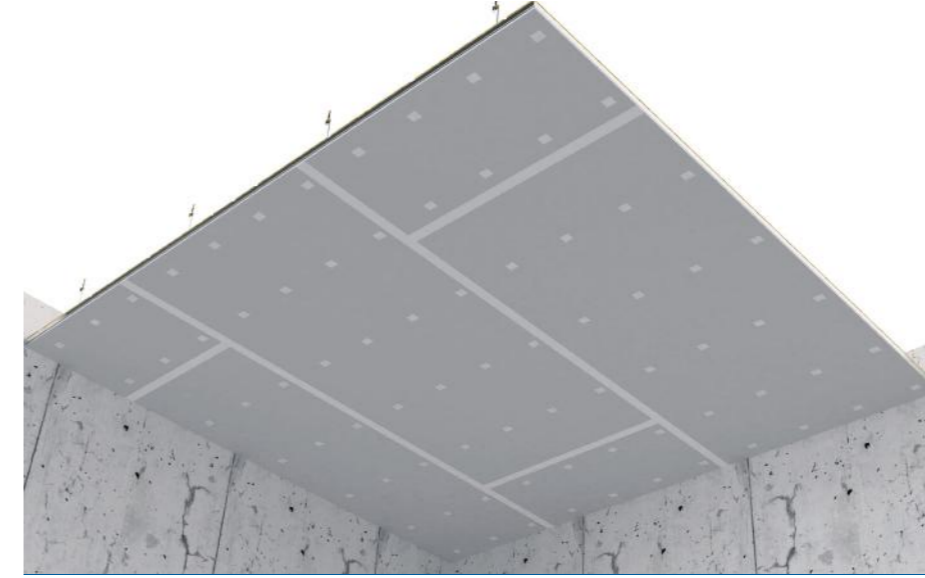

STEP 10

Covered joints and screw heads are filled with suitable jointing plaster, after the filling plaster dries, treated area is sandpapered and leveled with the board.



STEP 11

Satin plaster is applied, the surface is sandpapered.

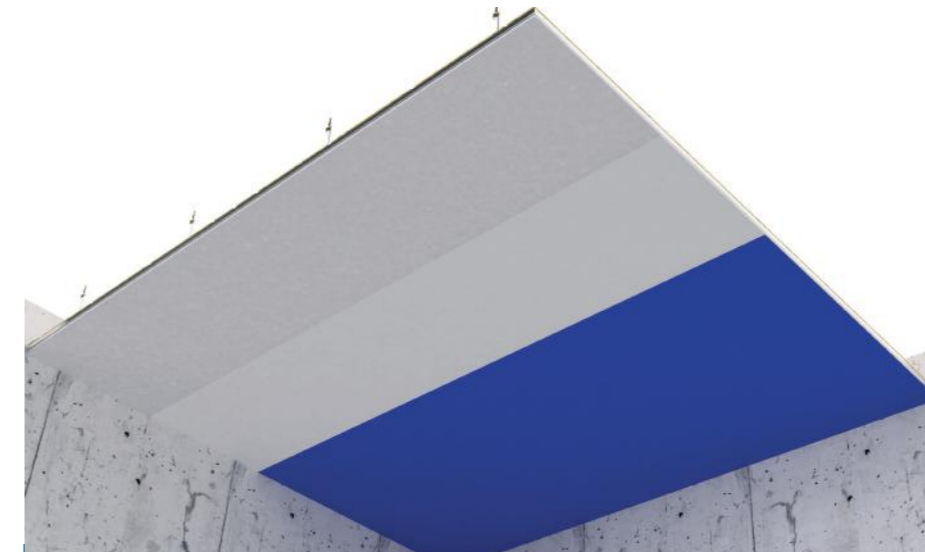

STEP 12

After the plaster is set, surface of the plasterboard is finished by applying primer and paint. Application is completed.

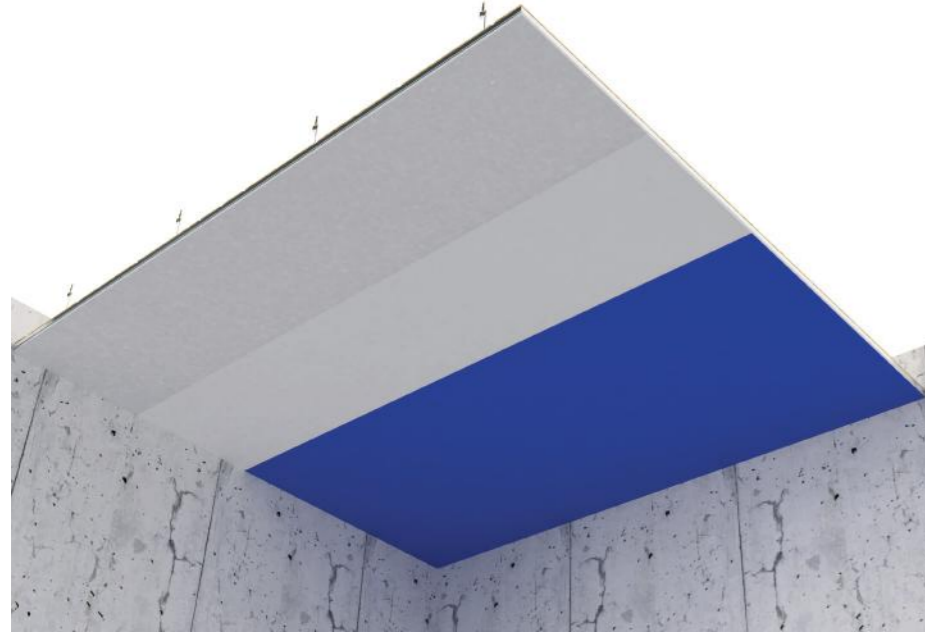

STEP 13

After the plaster is set, surface of the plasterboard is finished by applying primer and paint. Application is completed.

LOAD CARRYING TABLES FOR C47 PROFILE (FRENCH SYSTEM) SUSPENDED CEILING SYSTEM

MAXIMUM LOAD CARRYING TABLE WITH 0,50 MM CEILING C47 PROFILE

0,50 mm	Maximum Load Carrying (kg/m ²)			
	Suspension Rod Spacing (mm)			
Main Profile Spacing (m)	1100	1000	900	800
400 mm	20	27	37	53
500 mm	16	21	30	42

- *Values given in the tables are calculated by UMS with reference to AISI S100-2007 and Eurocode 3 Part 1.3.
- *Yield strength of the material is taken as 235 N/mm², deflection limit is taken as L/360 in calculations.
- *All values given above are calculated with reference to UMS profiles.
- *Allowable stresses are also taken into account in drawing up the table.
- *All values are calculated on the basis of the fact that plaster boards are screwed to the profiles with a spacing of 300 mm.
- *UMS recommends 900 mm and below for suspension rod axial spacings.

MAXIMUM LOAD CARRYING TABLE WITH 0,60 MM CEILING C47 PROFILE

0,60 mm	Maximum Load Carrying (kg/m ²)			
	Suspension Rod Spacing (mm)			
Main Profile Spacing (m)	1100	1000	900	800
400 mm	23	31	43	60
500 mm	18	25	34	49

- *Values given in the tables are calculated by UMS with reference to AISI S100-2007 and Eurocode 3 Part 1.3.
- *Yield strength of the material is taken as 235 N/mm², deflection limit is taken as L/360 in calculations.
- *All values given above are calculated with reference to UMS profiles.
- *Allowable stresses are also taken into account in drawing up the table.
- *All values are calculated on the basis of the fact that plaster boards are screwed to the profiles with a spacing of 300 mm.
- *UMS recommends 900 mm and below for suspension rod axial spacings.



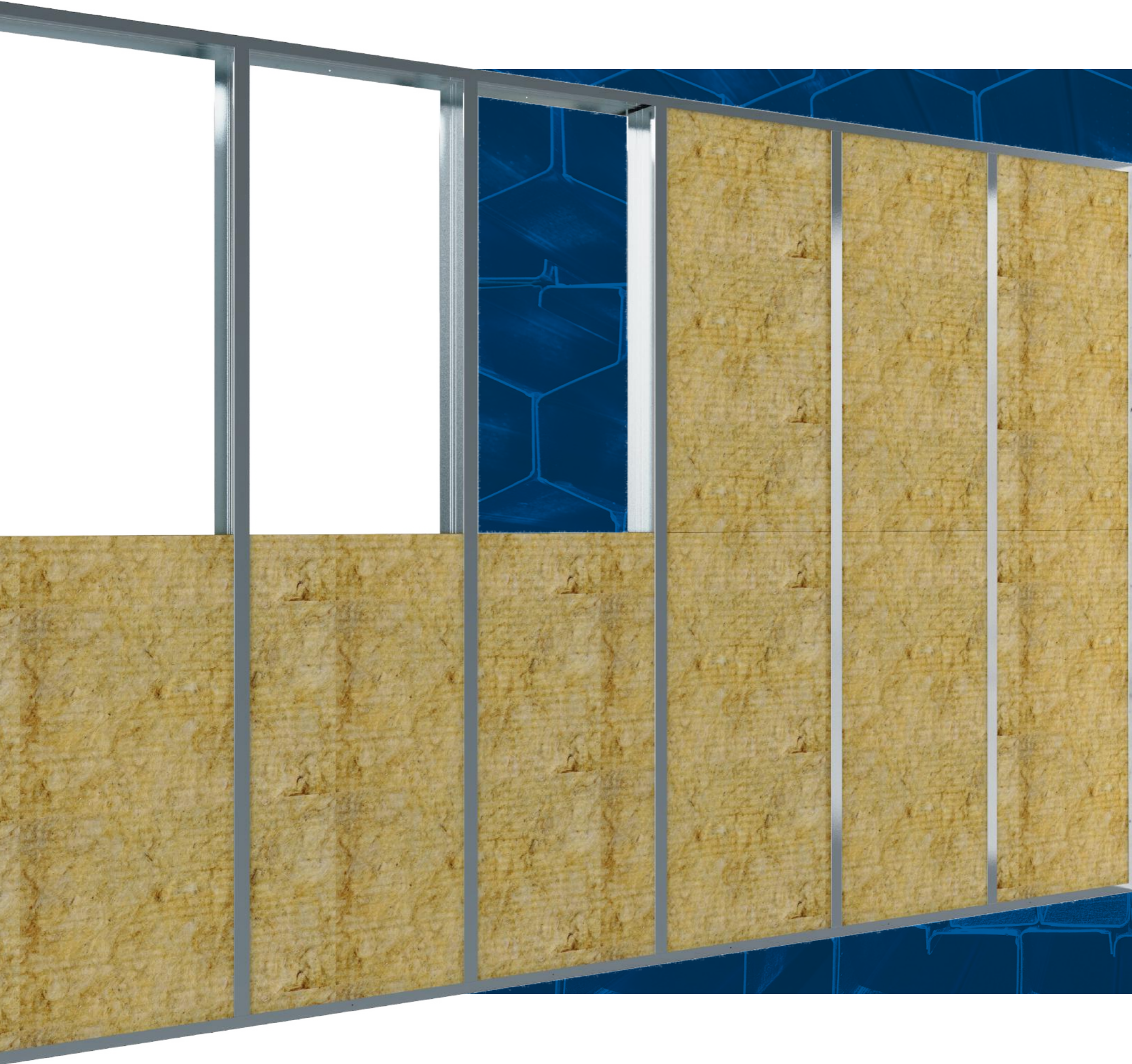

PARTITION WALL SYSTEMS

A frame system constructed from metal profile or timber lath in order to divide a space and ensure sound and heat insulation between divisions is called partition wall system. The system is made functional by coating with plasterboards or cement-based construction boards. Selection of profile may vary depending on the choice of system. UMS has all connection details and production diversity necessary for partition wall systems with UA profiles produced for Wall U, Wall C and reinforced door frames.

PARTITION WALL SYSTEMS

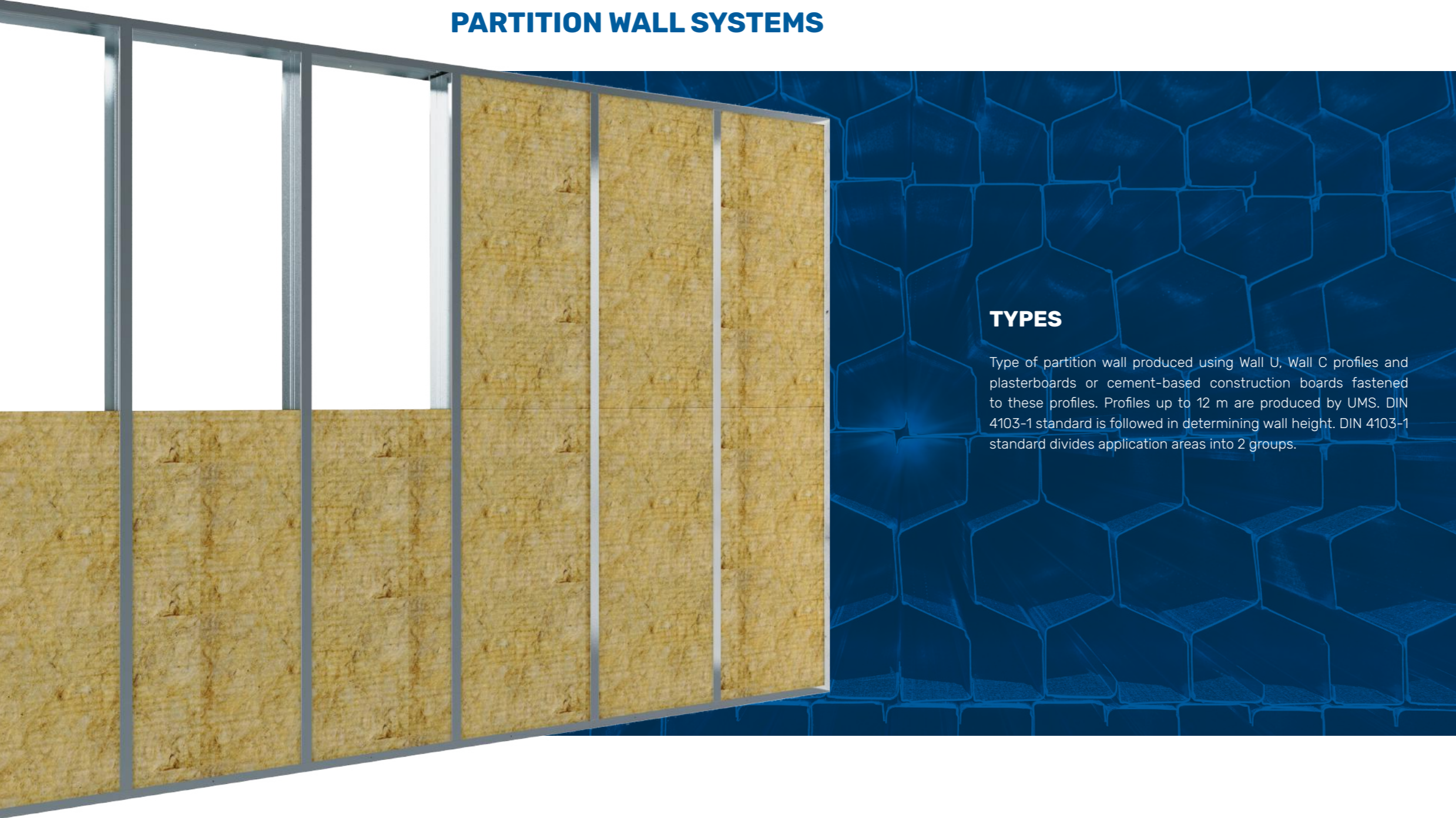

TYPES

Type of partition wall produced using Wall U, Wall C profiles and plasterboards or cement-based construction boards fastened to these profiles. Profiles up to 12 m are produced by UMS. DIN 4103-1 standard is followed in determining wall height. DIN 4103-1 standard divides application areas into 2 groups.

FEATURES

- Resistant to dynamic effects thanks to its flexibility,
- Because the profiles used are lightweight and high-strength, it provides 9 times more flexibility compared to brick walls in case of an earthquake,
- Provides high level sound and heat insulation if suitable boards and insulating materials are used,
- Saves time and labor as it allows quick and easy mounting-demounting,
- Does not cause loss of space as sections of the system are narrow,
- Allows concealing installations,
- Does not produce bacteria,
- Economical,
- Load amount per m² is 7.5 times less compared to brick wall,
- Using with appropriate board type is possible where fire resistance is required,
- Allows jointless passage, in a single part, of openings up to 12 m through profiles.

FIELDS OF USE

- Business and shopping centers
- Hospitals
- Industrial constructions
- Housings
- Office and management buildings
- Restored and renovated buildings
- Hotels
- Performance centers (Theatres and cinema halls, conservatories etc.)

PARTITION WALL SYSTEMS



APPLICATION AREA 1

Wall in spaces where few people are present: Houses, hotels, office and hospital buildings including their corridors, etc.

APPLICATION AREA 2

Walls in spaces where many people are present: Described as meeting rooms, conference rooms, show-sale areas and spaces with flooring height differences more than 1 m.

Metal construction partition wall systems are preferred in constructing space limiting, non-load bearing walls, installation walls, security walls, fire walls and shaft walls. Necessary partition wall systems to be preferred according to the wall type are as follows.

Space limiting, non-load bearing walls

- Single stud construction + Single layer board
- Single stud construction + Double layer board
- Single stud construction + Three-layer board
- Double-stud construction + Double layer board

Installation wall

- Double-stud construction + Double layer board

Security Wall

Single stud construction + Three-layer board + Steel

Fire Wall

- Single stud construction + Single layer board
- Single stud construction + Double-layer board + Steel board
- Single stud construction + Three-layer board + Steel board

Shaft Wall

- Free tensioned construction (without sub-construction) + Double layer board
- Metal tie beam construction + Double layer board
- Double-stud construction + Double layer board
- Combined metal double stud construction + double layer board

Timber construction partition wall

Type of partition wall constructed from timber lath, and plasterboards or cement-based construction boards fastened to these timber laths. DIN 4103-1 standard divided into two application areas is followed also for determining height of partition wall system constructed from timber boards.

Timber construction partition wall systems are preferred for constructing space limiting, non-load bearing walls. Necessary partition wall systems to be preferred according to the wall type are as follows.

Space limiting, non-load bearing walls

- Single stud construction + Single layer board
- Single stud construction + Double layer board
- Double-stud construction + Double layer board



SINGLE LAYER

Details of partition wall constructed from single stud construction and single layer board



THREE-LAYER

Details of partition wall constructed from single stud construction and three-layer board



DOUBLE-LAYER

Details of partition wall constructed from single stud construction and double layer board



DOUBLE STUD

Details of partition wall constructed from double stud construction and single layer board

APPLICATION

Material analysis given on the next page can be utilized for the quantity of materials to be consumed. UMS has specified limit values to be taken into consideration for partition wall application in the table on the next page.



LIMIT VALUE TABLE FOR PARTITION WALL

DESCRIPTION	LIMIT VALUE
Wall C Profile Spacing:	must be maximum 600 mm
Plaster Board Screw Spacing:	must be maximum 300 mm
Distance of Wall U Profile Starting and Ending Connections to the Walls:	must be maximum 50 mm
Wall U Profile Wall Plug Spacing:	must be maximum 600 mm

PARTITION WALL SYSTEM ANALYSIS TABLE

Type of Material	SINGLE STUD-SINGLE LAYER COATING		SINGLE STUD-DOUBLE LAYER COATING		SINGLE STUD-THREE LAYER COATING	
	SINGLE C	DOUBLE C	SINGLE C	DOUBLE C	SINGLE C	DOUBLE C
Plasterboard:	2,00 m ²		4,00 m ²		6,00 m ²	
Wall C Profile:	2,00 m ²	3,60 m ²	2,00 m ²	3,60 m ²	2,00 m ²	3,60 m ²
Wall U Profile:	0,80 m					
Perforated Corner Profile:	Ceiling Height x Number of Corners					
Joint Tape:	2,80 m					
Joint Plaster:	0,80 kg					
Drywall Screw (25 mm):	30 pcs	30 pcs	30 pcs	30 pcs	30 pcs	30 pcs
Drywall Screw (35 mm):	-	-	30 pcs	30 pcs	30 pcs	30 pcs
Drywall Screw (45 mm):	-	-	-	-	30 pcs	30 pcs
Wall plug-Shim-Screw:	2,20					
Insulation Material:	1,00 m ²					

*Consumptions may vary depending on project details.

COMPONENTS OF THE SYSTEM

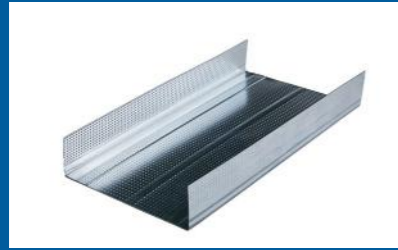

Wall U Profile

Type of non-load bearing wall profile that is needed to take Wall C profiles into the guide in a metal construction installed in constructing partition wall and to form a frame.



Wall C Profile

Type of load-bearing profile that forms partition wall frame as being used vertically. Can be produced up to 12 m.



Wall UA Profile

Profile type used to produce reinforced door frames.



UA Bracket

A type of bracket used to fix UA profiles, which are utilized to produce reinforced door frames, to ceiling and floor.



Steel Wall Plug

A fitting used in the mounting of wall U profiles on the floor.



Wall plug-Screw

A fastener used to wall-mount Ceiling U profiles.

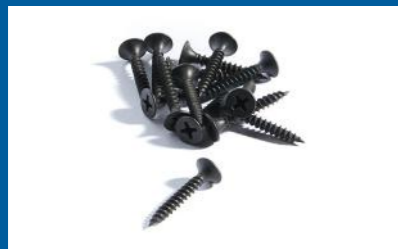

Drywall Screw

A fastener used to mount plaster boards to Wall U and Wall C profiles.



Perforated Corner Profile

A type of profile used for plaster board corners.



Sound Insulation Tape

Insulation tape applied to the face of Ceiling U Profiles that touches the wall in order to provide sound insulation for vibrations caused by construction.

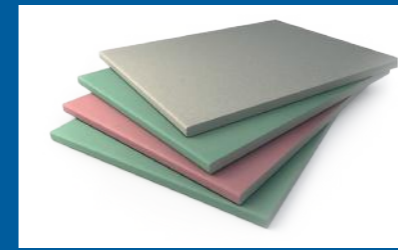

Plasterboard

Multi-purpose construction boards, coated with cardboard on both faces, with plaster in the center. There are 4 different types of plasterboard which are standard, water resistant, fire-resistant and water and fire resistant plasterboards. Due to high air permeability, provides significant contribution in balancing ambient humidity, and in ensuring sound and heat insulation when used with proper insulation material.



Joint Tape

A type of netting used to equally block joints remaining between plasterboards using joint sealant and to prevent cleavage at the joint points.



Insulation Material

Mineral wool of different density and thickness values used to increase heat insulation, sound insulation and resistance to fire.

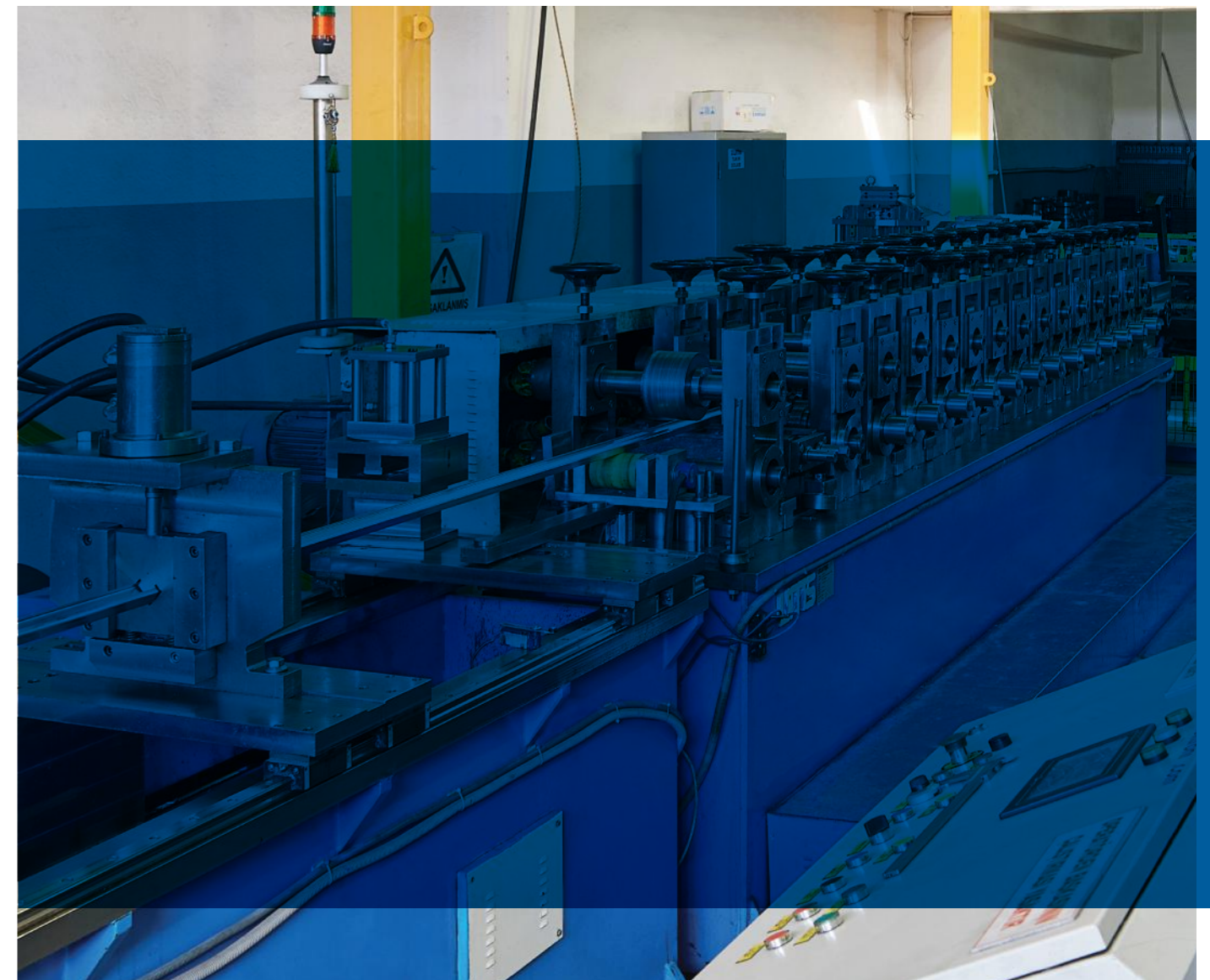

Order of operations given below should be followed for a complete application.

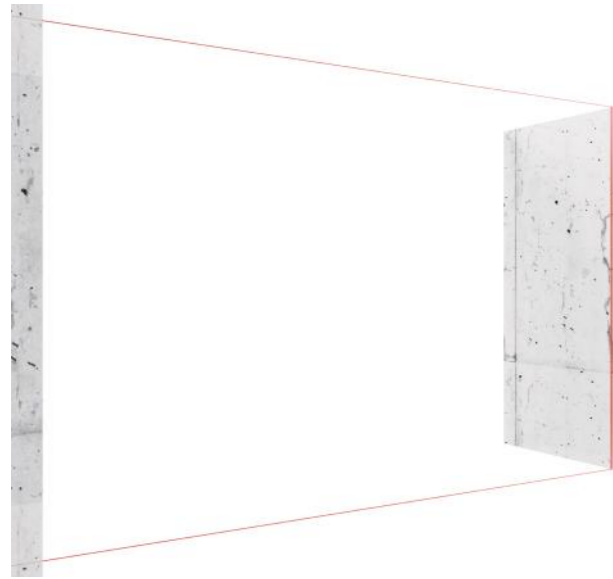

STEP 1

Location of Wall U profiles to be applied to the floor and ceiling is determined using auxiliary equipment including laser, chalk line, water balance etc.



STEP 2

Wall U profiles, as sound insulation tape applied to the side that faces ceiling and floor, are fixed to the ceiling and floor with a distance of 50 mm from both ends and with a spacing of 600 mm, using suitable type of wall plug.

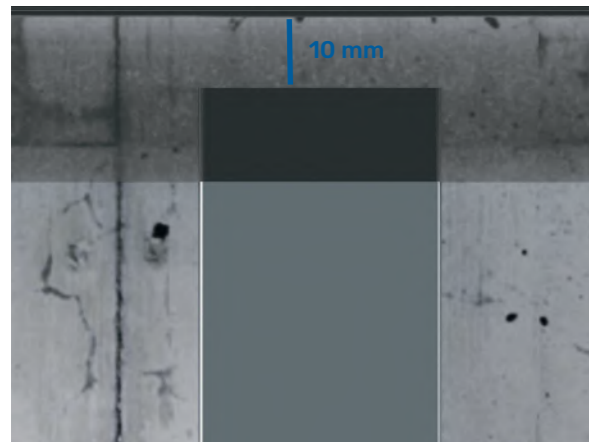

STEP 3

Wall C profiles to be used vertically are cut 10 mm shorter than ceiling height.



STEP 4

Parts of the Wall C profiles to form partition wall frame that touch the wall are affixed sound insulation tape and Wall C profiles on the edges are made ready for application. Wall C profiles that are affixed sound insulation tape so that surfaces with insulation tape face the side touching the wall, are turned and placed in Wall U profiles and partition wall frame is formed.



STEP 5

Wall C profile sizes, thicknesses, axial spacings and number of plaster board coatings are determined using height calculation tables given at the end of the chapter. Wall C profiles with profile openings in the same direction so that they face application direction of the board, are placed in between Wall U profiles according to determined axial spacings. (in wet area single layer plasterboard applications, Wall C profile axial spacings should not exceed 400 mm for ceramic, marble coating etc.)



STEP 6

In case double Wall C profile is used, back-to-back Wall C profiles should be screwed to each other with metal-to-metal screw with a maximum spacing of 750 mm.



STEP 7

Following completion of construction, plaster boards are mounted on one side in a zigzag course.



STEP 8

Installation pipes and wires are passed through the construction, which is coated on one side, using the holes on the profile in accordance with the project, and insulation materials, if any, are stuffed and placed between Wall C profiles.

*Following steps are written with reference to plaster board application. Order and content of steps may vary when different materials are used.

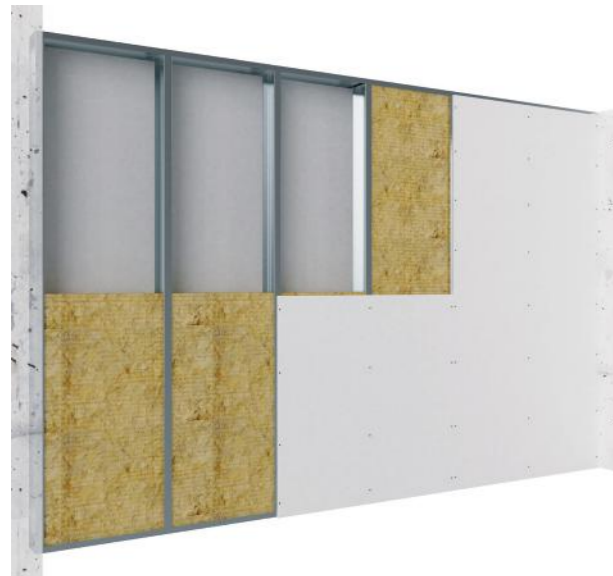

STEP 9

Plasterboards are mounted on Wall C profiles by means of drywall screws utilizing the tables below so that short sides face floor and ceiling. Prior to mounting, plaster boards should be cut 10-15 mm shorter than ceiling height in order to prevent moisture and contact with ceiling.

VERTICAL SCREW SPACINGS ACCORDING TO PLASTERBOARD LAYER

Plasterboard	Vertical Screw Spacing (mm)		
	First Layer	Second Layer	Third Layer
In single layer applications	≤ 300	-	-
In double layer applications	≤ 750	≤ 300	-
In three-layer applications	≤ 750	≤ 500	≤ 300

SCREW LENGTHS ACCORDING TO PLASTERBOARD LAYER

Plasterboard	Screw Lengths (mm)		
	First Layer	Second Layer	Third Layer
12,5	25	-	-
15	25	-	-
18-20	35	-	-
2x12,5	25	35	-
15+12,5	25	45	-
2x15	25	45	-
18+15	35	45	-
3x12,5	25	35	55

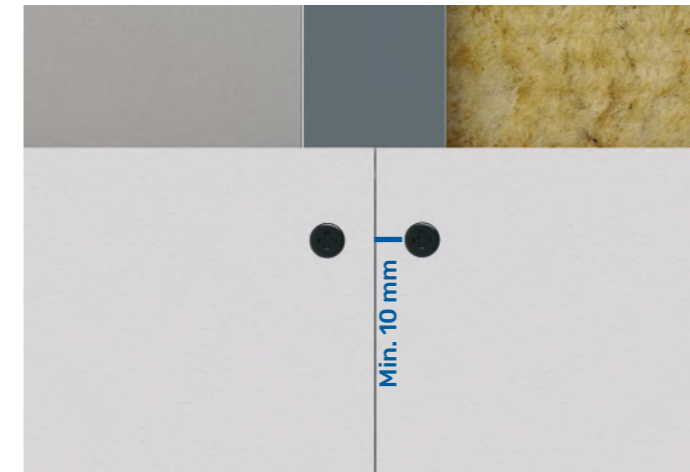

STEP 10

Attention should be paid not to tear surface coatings of plaster boards. Joining points should centre Wall C profiles without any gaps, at least 10 mm should be left from the board edges when screwing.

Order of operations given below should be followed for a complete application.

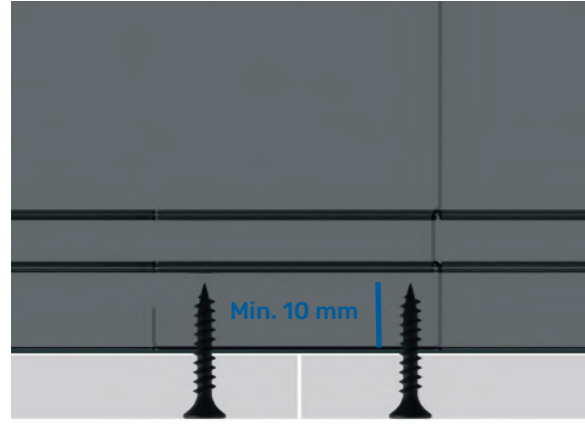

STEP 11

Length of the screws should exceed at least 10 mm the side of the plasterboard that touches the profile. When selecting screws, sharp point screws should be preferred up to 0,70 mm profile thickness and self-drilling screws up to 0,70-2,25 mm profile thickness.



STEP 12

Countersunk heads of screws should be sunk into the surface as much as the board coating thickness. If mistakenly screwed deeper, the screws in question should be unscrewed and screwed again as described with a 50-60 mm distance to screw hole.

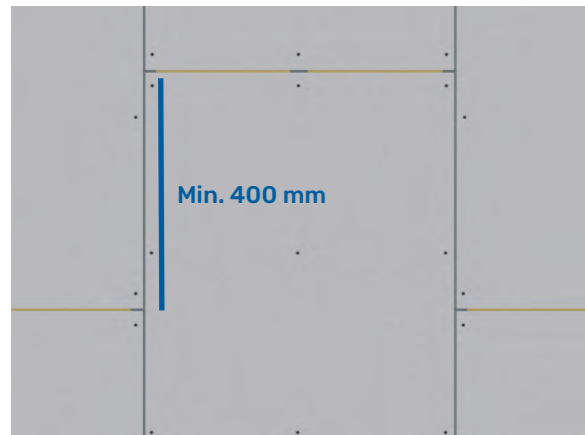

STEP 13

Joining points of plaster boards on the horizontal axis should be staggered. In single layer plasterboard applications, joint spacings on one side should be staggered at least 400 mm while in double layer applications horizontal joints should be staggered 250 mm on the vertical, vertical joints should be staggered as much as Wall C profile axial spacing. For baffling joints on corresponding sides, if one surface starts with a full board the other surface should be applied with a half board.



STEP 14

After completion of board mounting, joining points are covered with joint tape.



STEP 15

Screw heads that jut out on the plasterboard surface are checked, screwed with a screwdriver to be leveled with the surface and all screw heads, joint cavities are covered with joint plaster.

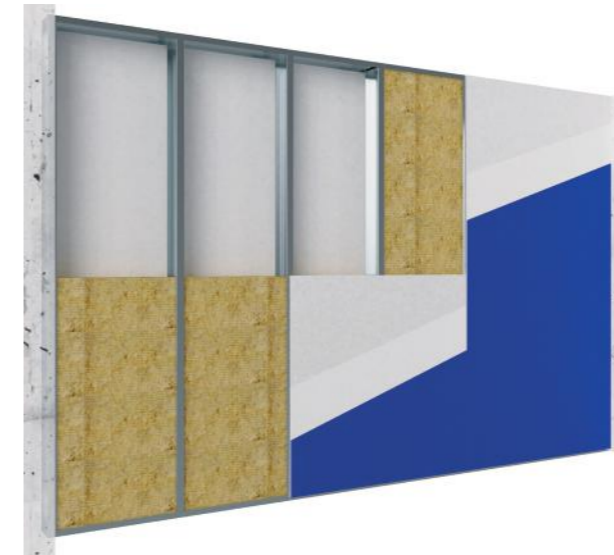

STEP 16

Drying of joint plaster is awaited. After drying, it is leveled with the surface using sandpaper. The surface is dedusted and then one coat of primer and two coats of paint are applied and the work is finished.

MAXIMUM HEIGHT CALCULATION TABLE WITH WALL C50 PROFILE AND ONE-COAT OF PLASTERBOARD

Sizes	Material Thickness (mm)	Maximum Wall Height (m)				Plasterboard Thickness (mm)	Partition Wall Thickness (mm)
		Axial Spacing (60 cm)		Axial Spacing (40 cm)			
		SINGLE C	DOUBLE C	SINGLE C	DOUBLE C		
35/49/35	0,40	3,24	3,64	3,34	3,84	12,50 +	75
	0,45	3,40	3,85	3,52	4,00		
	0,50	3,56	3,88	3,70	4,04		
	0,60	3,73	3,94	3,83	4,12		
	0,70	3,76	3,99	3,88	4,19		
	0,80	3,78	4,03	3,91	4,26		
42/49/42	0,40	-	-	-	-		
	0,45	3,27	3,74	3,40	3,98		
	0,50	3,42	3,93	3,57	4,14		
	0,60	3,71	4,01	3,90	4,23		
	0,70	3,81	4,07	3,95	4,31		
	0,80	3,84	4,13	3,99	4,35		
47/49/47	0,40	-	-	-	-		
	0,45	-	-	-	-		
	0,50	3,36	3,89	3,51	4,16		
	0,60	3,62	4,07	3,81	4,30		
	0,70	3,84	4,14	3,99	4,35		
	0,80	3,88	4,20	4,04	4,35		

MAXIMUM HEIGHT CALCULATION TABLE WITH SINGLE STUD WALL C75 PROFILE AND ONE-COAT OF PLASTERBOARD

Sizes	Material Thickness (mm)	Maximum Wall Height (m)				Plasterboard Thickness (mm)	Partition Wall Thickness (mm)
		Axial Spacing (60 cm)		Axial Spacing (40 cm)			
		SINGLE C	DOUBLE C	SINGLE C	DOUBLE C		
35/49/35	0,40	3,85	4,28	3,99	4,54	12,50 +	100
	0,45	4,03	4,52	4,19	4,81		
	0,50	4,21	4,76	4,39	5,09		
	0,60	4,58	5,03	4,80	5,30		
	0,70	4,77	5,10	4,94	5,40		
	0,80	4,81	5,17	5,00	5,49		
42/49/42	0,40	-	-	-	-		
	0,45	3,93	4,45	4,09	4,75		
	0,50	4,09	4,67	4,29	5,02		
	0,60	4,44	5,14	4,68	5,44		
	0,70	4,79	5,23	5,04	5,56		
	0,80	4,89	5,31	5,11	5,67		
47/49/47	0,40	-	-	-	-		
	0,45	-	-	-	-		
	0,50	4,05	4,65	4,24	4,99		
	0,60	4,36	5,09	4,60	5,51		
	0,70	4,69	5,31	4,99	5,67		
	0,80	4,94	5,40	5,18	5,79		

*All values given above are calculated with reference to UMS profiles.

MAXIMUM HEIGHT CALCULATION TABLE WITH SINGLE STUD WALL C100 PROFILE AND ONE-COAT OF PLASTERBOARD

Sizes	Material Thickness (mm)	Maximum Wall Height (m)				Plasterboard Thickness (mm)	Partition Wall Thickness (mm)
		Axial Spacing (60 cm)		Axial Spacing (40 cm)			
		SINGLE C	DOUBLE C	SINGLE C	DOUBLE C		
35/99/35	0,40	4,34	4,79	4,50	5,08	12,50 +	125
	0,45	4,53	5,04	4,72	5,37		
	0,50	4,72	5,29	4,93	5,66		
	0,60	5,10	5,80	5,37	6,25		
	0,70	5,50	6,12	5,83	6,49		
	0,80	5,74	6,20	5,98	6,60		
42/99/42	0,40	-	-	-	-		
	0,45	4,47	5,02	4,66	5,37		
	0,50	4,65	5,27	4,88	5,66		
	0,60	5,02	5,77	5,31	6,25		
	0,70	5,40	6,27	5,74	6,69		
	0,80	5,79	6,37	6,12	6,83		
47/99/47	0,40	-	-	-	-		
	0,45	-	-	-	-		
	0,50	4,63	5,27	4,86	5,67		
	0,60	4,97	5,75	5,26	6,24		
	0,70	5,33	6,25	5,68	6,83		
	0,80	5,71	6,49	6,11	6,98		

MAXIMUM HEIGHT CALCULATION TABLE WITH SINGLE STUD WALL C 125 PROFILE AND ONE-COAT OF PLASTERBOARD

Sizes	Material Thickness (mm)	Maximum Wall Height (m)				Plasterboard Thickness (mm)	Partition Wall Thickness (mm)
		Axial Spacing (60 cm)		Axial Spacing (40 cm)			
		SINGLE C	DOUBLE C	SINGLE C	DOUBLE C		
49/124/49	0,40	-	-	-	-	12,50 +	150
	0,45	-	-	-	-		
	0,50	-	-	-	-		
	0,60	5,49	6,31	5,82	6,86		
	0,70	5,86	6,83	6,25	7,47		
	0,80	6,25	7,36	6,71	8,10		

MAXIMUM HEIGHT CALCULATION TABLE WITH SINGLE STUD WALL C 150 PROFILE AND ONE-COAT OF PLASTERBOARD

Sizes	Material Thickness (mm)	Maximum Wall Height (m)				Plasterboard Thickness (mm)	Partition Wall Thickness (mm)
		Axial Spacing (60 cm)		Axial Spacing (40 cm)			
		SINGLE C	DOUBLE C	SINGLE C	DOUBLE C		
49/149/49	0,40	-	-	-	-	12,50 +	175
	0,45	-	-	-	-		
	0,50	-	-	-	-		
	0,60	-	-	-	-		
	0,70	6,32	7,32	6,75	8,00		
	0,80	6,72	7,87	7,22	8,64		

*All values given above are calculated with reference to UMS profiles.

MAXIMUM HEIGHT CALCULATION TABLE WITH SINGLE STUD WALL C 50 PROFILE AND TWO-COATS OF PLASTERBOARD

Sizes	Material Thickness (mm)	Maximum Wall Height (m)				Plasterboard Thickness (mm)	Partition Wall Thickness (mm)
		Axial Spacing (60 cm)		Axial Spacing (40 cm)			
		SINGLE C	DOUBLE C	SINGLE C	DOUBLE C		
35/49/35	0,40	3,77	4,27	3,84	4,35	12,50x2 + 12,50x2	100
	0,45	3,92	4,35	4,00	4,35		
	0,50	4,08	4,35	4,18	4,35		
	0,60	4,35	4,35	4,35	4,35		
	0,70	4,35	4,35	4,35	4,35		
	0,80	4,35	4,35	4,35	4,35		
42/49/42	0,40	-	-	-	-		
	0,45	3,81	4,35	3,89	4,35		
	0,50	3,94	4,35	4,04	4,35		
	0,60	4,23	4,35	4,36	4,35		
	0,70	4,42	4,35	4,42	4,35		
	0,80	4,42	4,35	4,42	4,35		
47/49/47	0,40	-	-	-	-		
	0,45	-	-	-	-		
	0,50	3,87	4,35	3,97	4,35		
	0,60	4,13	4,35	4,26	4,35		
	0,70	4,42	4,35	4,26	4,35		
	0,80	4,42	4,35	4,26	4,35		

MAXIMUM HEIGHT CALCULATION TABLE WITH SINGLE STUD WALL C 75 PROFILE AND TWO-COATS OF PLASTERBOARD

Sizes	Material Thickness (mm)	Maximum Wall Height (m)				Plasterboard Thickness (mm)	Partition Wall Thickness (mm)
		Axial Spacing (60 cm)		Axial Spacing (40 cm)			
		SINGLE C	DOUBLE C	SINGLE C	DOUBLE C		
35/74/35	0,40	4,39	4,84	4,47	5,00	12,50x2 + 12,50x2	125
	0,45	4,54	5,04	4,65	5,23		
	0,50	4,71	5,26	4,82	5,48		
	0,60	5,06	5,72	5,21	6,00		
	0,70	5,45	6,21	5,64	6,21		
	0,80	5,88	6,21	6,11	6,21		
42/74/42	0,40	-	-	-	-		
	0,45	4,50	5,03	4,60	5,24		
	0,50	4,64	5,23	4,77	5,47		
	0,60	4,95	5,65	5,11	5,94		
	0,70	5,29	6,10	5,48	6,40		
	0,80	5,65	6,40	5,89	6,40		
47/74/47	0,40	-	-	-	-		
	0,45	-	-	-	-		
	0,50	4,60	5,21	4,73	5,45		
	0,60	4,89	5,61	5,05	5,91		
	0,70	5,20	6,03	5,40	6,39		
	0,80	5,53	6,47	5,77	6,47		

*All values given above are calculated with reference to UMS profiles.

MAXIMUM HEIGHT CALCULATION TABLE WITH SINGLE STUD WALL C 100 PROFILE AND TWO-COATS OF PLASTERBOARD

Sizes	Material Thickness (mm)	Maximum Wall Height (m)				Plasterboard Thickness (mm)	Partition Wall Thickness (mm)
		Axial Spacing (60 cm)		Axial Spacing (40 cm)			
		SINGLE C	DOUBLE C	SINGLE C	DOUBLE C		
35/99/35	0,40	4,82	5,23	4,93	5,42	12,50x2 + 12,50x2	150
	0,45	4,98	5,44	5,10	5,66		
	0,50	5,14	5,64	5,28	5,89		
	0,60	5,48	6,09	5,66	6,41		
	0,70	5,87	6,59	6,08	6,98		
	0,80	6,30	7,14	6,56	7,61		
42/99/42	0,40	-	-	-	-		
	0,45	5,01	5,52	5,14	5,76		
	0,50	5,17	5,73	5,32	6,00		
	0,60	5,48	6,15	5,67	6,48		
	0,70	5,82	6,60	6,05	7,01		
	0,80	6,19	7,09	6,49	7,57		
47/99/47	0,40	-	-	-	-		
	0,45	-	-	-	-		
	0,50	5,17	5,76	5,32	6,04		
	0,60	5,47	6,14	5,66	6,52		
	0,70	5,79	6,61	6,02	7,02		
	0,80	6,13	7,07	6,41	7,56		

MAXIMUM HEIGHT CALCULATION TABLE WITH SINGLE STUD WALL C 125 PROFILE AND TWO-COATS OF PLASTERBOARD

Sizes	Material Thickness (mm)	Maximum Wall Height (m)				Plasterboard Thickness (mm)	Partition Wall Thickness (mm)
		Axial Spacing (60 cm)		Axial Spacing (40 cm)			
		SINGLE C	DOUBLE C	SINGLE C	DOUBLE C		
49/124/49	0,40	-	-	-	-	12,50x2 + 12,50x2	175
	0,45	-	-	-	-		
	0,50	-	-	-	-		
	0,60	5,94	6,64	6,16	7,03		
	0,70	6,26	7,08	6,52	7,54		
	0,80	6,59	7,54	6,90	8,07		

MAXIMUM HEIGHT CALCULATION TABLE WITH SINGLE STUD WALL C 150 PROFILE AND TWO-COATS OF PLASTERBOARD

Sizes	Material Thickness (mm)	Maximum Wall Height (m)				Plasterboard Thickness (mm)	Partition Wall Thickness (mm)
		Axial Spacing (60 cm)		Axial Spacing (40 cm)			
		DOUBLE C	SINGLE C	DOUBLE C	ÇİFT C		
49/149/49	0,40	-	-	-	-	12,50x2 + 12,50x2	200
	0,45	-	-	-	-		
	0,50	-	-	-	-		
	0,60	-	-	-	-		
	0,70	6,64	7,45	6,93	7,94		
	0,80	6,97	7,90	7,31	8,46		

*All values given above are calculated with reference to UMS profiles.

MAXIMUM HEIGHT CALCULATION TABLE WITH SINGLE STUD WALL C 50 PROFILE AND THREE-COATS OF PLASTERBOARD

Sizes	Material Thickness (mm)	Maximum Wall Height (m)				Plasterboard Thickness (mm)	Partition Wall Thickness (mm)
		Axial Spacing (60 cm)		Axial Spacing (40 cm)			
		SINGLE C	DOUBLE C	SINGLE C	DOUBLE C		
35/49/35	0,40	3,98	4,35	4,03	4,35	12,50x3 + 12,50x3	125
	0,45	4,13	4,35	4,19	4,35		
	0,50	4,29	4,35	4,35	4,35		
	0,60	4,35	4,35	4,35	4,35		
	0,70	4,35	4,35	4,35	4,35		
	0,80	4,35	4,35	4,35	4,35		
42/49/42	0,40	-	-	-	-		
	0,45	4,02	4,35	4,09	4,35		
	0,50	4,16	4,35	4,23	4,35		
	0,60	4,42	4,35	4,42	4,35		
	0,70	4,42	4,35	4,42	4,35		
	0,80	4,42	4,35	4,42	4,35		
47/49/47	0,40	-	-	-	-		
	0,45	-	-	-	-		
	0,50	4,08	4,35	4,16	4,35		
	0,60	4,34	4,35	4,42	4,35		
	0,70	4,42	4,35	4,42	4,35		
	0,80	4,42	4,35	4,42	4,35		

MAXIMUM HEIGHT CALCULATION TABLE WITH SINGLE STUD WALL C 75 PROFILE AND THREE-COATS OF PLASTERBOARD

Sizes	Material Thickness (mm)	Maximum Wall Height (m)				Plasterboard Thickness (mm)	Partition Wall Thickness (mm)
		Axial Spacing (60 cm)		Axial Spacing (40 cm)			
		SINGLE C	DOUBLE C	SINGLE C	DOUBLE C		
35/74/35	0,40	4,61	5,08	4,67	5,21	12,50x3 + 12,50x3	150
	0,45	4,75	5,27	4,83	5,42		
	0,50	4,91	5,47	4,99	5,64		
	0,60	5,25	5,92	5,37	6,14		
	0,70	5,66	6,21	5,80	6,21		
	0,80	6,10	6,21	6,25	6,21		
42/74/42	0,40	-	-	-	-		
	0,45	4,74	5,31	4,82	5,47		
	0,50	4,88	5,49	4,97	5,68		
	0,60	5,17	5,89	5,29	6,12		
	0,70	5,50	6,32	5,65	6,40		
	0,80	5,87	6,40	6,06	6,40		
47/74/47	0,40	-	-	-	-		
	0,45	-	-	-	-		
	0,50	4,85	5,50	4,95	5,69		
	0,60	5,12	5,87	5,25	6,11		
	0,70	5,42	6,27	5,57	6,47		
	0,80	5,75	6,47	5,94	6,47		

*All values given above are calculated with reference to UMS profiles.

MAXIMUM HEIGHT CALCULATION TABLE WITH SINGLE STUD WALL C 100 PROFILE AND THREE-COATS OF PLASTERBOARD

Sizes	Material Thickness (mm)	Maximum Wall Height (m)				Plasterboard Thickness (mm)	Partition Wall Thickness (mm)
		Axial Spacing (60 cm)		Axial Spacing (40 cm)			
		SINGLE C	DOUBLE C	SINGLE C	DOUBLE C		
35/99/35	0,40	5,02	5,41	5,10	5,56	12,50x3 + 12,50x3	175
	0,45	5,16	5,59	5,25	5,76		
	0,50	5,31	5,78	5,41	5,97		
	0,60	5,63	6,20	5,76	6,45		
	0,70	6,00	6,68	6,17	6,99		
	0,80	6,43	7,21	6,64	7,59		
42/99/42	0,40	-	-	-	-		
	0,45	5,25	5,75	5,35	5,94		
	0,50	5,39	5,93	5,50	6,14		
	0,60	5,67	6,31	5,81	6,58		
	0,70	5,99	6,74	6,17	7,06		
	0,80	6,35	7,21	6,56	7,60		
47/99/47	0,40	-	-	-	-		
	0,45	-	-	-	-		
	0,50	5,42	6,01	5,53	6,23		
	0,60	5,69	6,37	5,83	6,65		
	0,70	5,98	6,77	6,16	7,11		
	0,80	6,31	7,21	6,52	7,61		

MAXIMUM HEIGHT CALCULATION TABLE WITH SINGLE STUD WALL C 125 PROFILE AND THREE-COATS OF PLASTERBOARD

Sizes	Material Thickness (mm)	Maximum Wall Height (m)				Plasterboard Thickness (mm)	Partition Wall Thickness (mm)
		Axial Spacing (60 cm)		Axial Spacing (40 cm)			
		SINGLE C	DOUBLE C	SINGLE C	DOUBLE C		
49/124/49	0,40	-	-	-	-	12,50x2 + 12,50x2	200
	0,45	-	-	-	-		
	0,50	-	-	-	-		
	0,60	6,14	6,80	6,31	7,10		
	0,70	6,42	7,18	6,63	7,54		
	0,80	6,73	7,59	6,97	8,03		

MAXIMUM HEIGHT CALCULATION TABLE WITH SINGLE STUD WALL C 150 PROFILE AND THREE-COATS OF PLASTERBOARD

Sizes	Material Thickness (mm)	Maximum Wall Height (m)				Plasterboard Thickness (mm)	Partition Wall Thickness (mm)
		Axial Spacing (60 cm)		Axial Spacing (40 cm)			
		SINGLE C	DOUBLE C	SINGLE C	DOUBLE C		
49/149/49	0,40	-	-	-	-	12,50x2 + 12,50x2	200
	0,45	-	-	-	-		
	0,50	-	-	-	-		
	0,60	-	-	-	-		
	0,70	6,76	7,47	6,98	7,86		
	0,80	7,06	7,87	7,32	8,33		

*All values given above are calculated with reference to UMS profiles.

CONSTRUCTING DOOR AND WINDOW FRAMES WITH WALL U AND WALL C PROFILES



STEP 1

For mounting door and window frames, Wall U and Wall C profiles are intertwined and screwed to each other at the flank surfaces. Wall U - Wall C profiles which are made into box profile and gained characteristics of a carrier profile for door and window, are placed into bottom and ceiling Wall U profiles and attached by means of drywall screw or plier clamp.



STEP 2

For horizontal planes where window or door frame fit into, Wall U profiles form cuts in the flanks and are bended 90° with a distance of at least 200 mm from both sides. Bended parts are leveled and screwed to the studs, which have been made into box profile on the edges, with metal-to-metal screw and lintel is mounted.



STEP 3

For door and window openings, Wall C profile of suitable size is placed, with a spacing of at least 150 mm from Wall U - Wall C box profile, into the places that stay under and over the lintel. Axial spacing of Wall C profiles placed should not exceed 400 mm.



STEP 4

Attention should be paid to place the plasterboards in a way that they do not coincide with the lintel and Wall U - Wall C box profiles on the sides of the frame and that the joining points are mounted by staggering.

PRODUCING DOOR AND WINDOW FRAMES WITH WALL UA PROFILES



STEP 1

UA profiles of 2 mm thickness specially produced by UMS for mounting door and window frames are placed in bottom and ceiling Wall U profiles and mounted on brackets produced exclusively for UA profiles using nut, bolt, wall plug and screw. Wall UA profiles have slot holes for easy fixing to brackets with nuts-bolts. Wall UA 50 profiles have slot holes in a single line while Wall UA 75 and 100 profiles have slot holes in double line.



STEP 2

For horizontal planes where window or door frame fit into, Wall U profiles form cuts in the flanks and are bended 90° with a distance of at least 200 mm from both sides. Bended parts are leveled and screwed with metal-to-metal screw to Wall UA profiles that are lined up back-to-back and serve as carrier on the edges and lintel is mounted.



STEP 3

For door and window openings, Wall C profile of suitable size is placed, with a spacing of at least 150 mm from Wall UA profile, into the places that stay under and over the lintel. Axial spacing of Wall C profiles placed should not exceed 400 mm.



STEP 4

Attention should be paid to place the plasterboards in a way that they do not coincide with the lintel and Wall UA profiles on the sides of the frame and that the joining points are mounted by staggering.

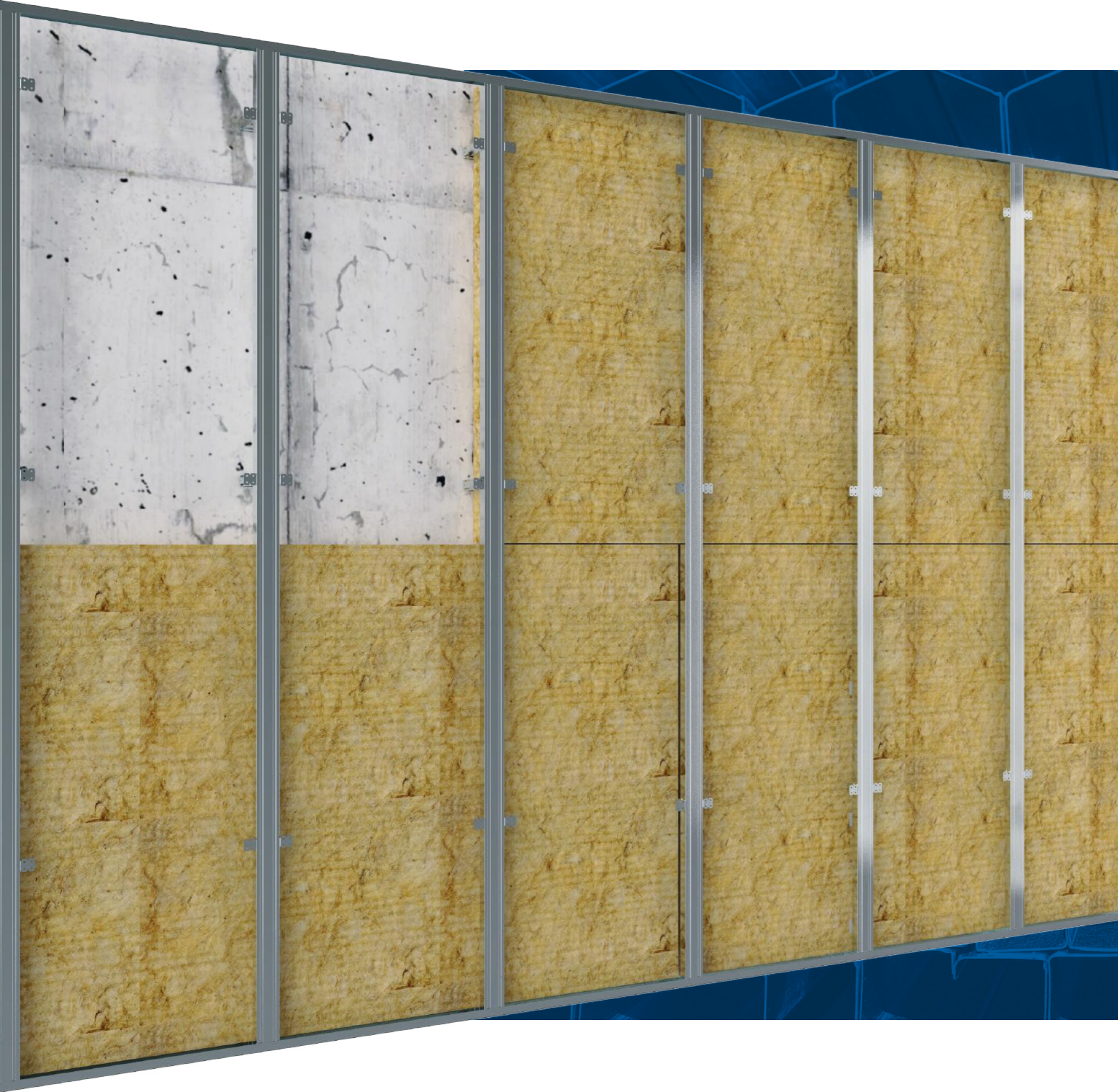

WALL CLADDING SYSTEMS

A wall cladding system made by using Ceiling C, Ceiling U and brackets in order to level wall surface, form a planar surface and/or gain an aesthetic appearance.

WALL CLADDING SYSTEMS



TYPES

WALL CLADDING SYSTEM DEPENDENT ON EXISTING WALL

This is a wall cladding system created by mounting carrier metal profiles on brick, pumice, gas concrete, wood, concrete, reinforced concrete etc. present in the construction and by applying plasterboards on these profiles.

WALL CLADDING SYSTEM INDEPENDENT OF EXISTING WALL

This is a wall cladding system created by applying plasterboards on the frame formed by carrier metal profiles independent of existing wall in the construction.

FEATURES

- Resistant to dynamic effects thanks to its flexibility,
- Provides formation of a planar surface, with a leveled and smooth wall,
- Provides high level sound and heat insulation if suitable boards and insulating materials are used,
- Saves time and labor as it allows quick and easy mounting-demounting,
- Does not cause loss of space as sections of the system are narrow,
- Allows concealing installations,
- Does not produce bacteria,
- Economical,
- Aesthetical,
- Using with appropriate board type is possible where fire resistance is required,

FIELDS OF USE

- Business and shopping centers
- Hospitals
- Industrial constructions
- Spaces that require sound and heat insulation
- Housings
- Office and management buildings
- Restored and renovated buildings
- Hotels
- Performance centers (Theatres and cinema halls, conservatories etc.)
- Recording studios

COMPONENTS OF THE SYSTEM

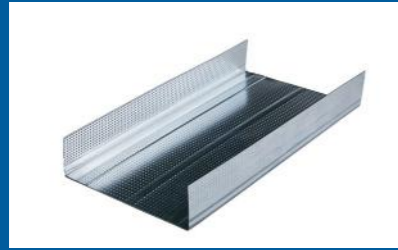

Wall U Profile

Type of non-load bearing wall profile that is needed to take Wall C profiles into the guide in a metal construction installed in constructing partition wall and to form a frame.

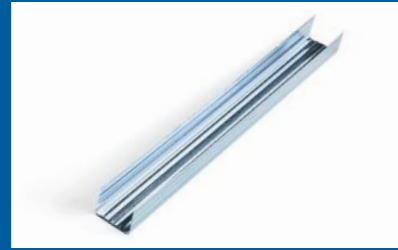

Ceiling U Profile

It is a non-load bearing ceiling profile needed for alignment of carrier Ceiling C profiles in the metal construction built to make suspended ceiling and for leveling of the system.



Ceiling C Profile

Divided into two as main carrier profile and auxiliary carrier profile. Main carrier Ceiling C profile is the term used for Ceiling C profile hung on hanger clip and placed in the upper point of the system. Auxiliary Ceiling C Profile is the term used for Ceiling C Profile that is fastened to the main carrier Ceiling C profile by the help of clip and on which plasterboards are mounted.

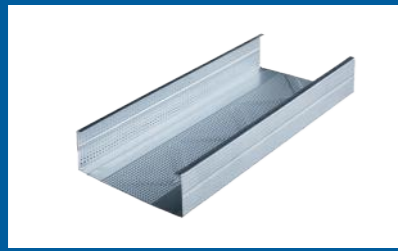

Wall C Profile

Type of carrier profile that forms the clad wall frame by being used on the vertical in wall cladding system dependent on existing wall. Can be produced up to 12 m.



Bracket

A fastener used for mounting Ceiling C profiles on the wall and adjusting variations from the plumb line on the wall.



Sound Insulation Tape

Insulation tape used between the wall and Wall U Profile in order to ensure sound insulation for vibrations caused by the construction.



Wall plug-Screw

A fastener used to mount Ceiling U profiles and brackets.

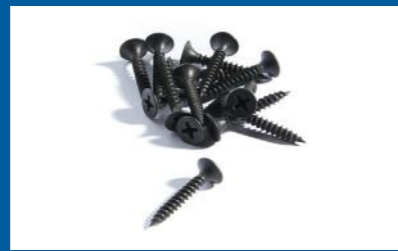

Drywall Screw

A fastener used to mount plaster boards to Wall U and Wall C profiles.

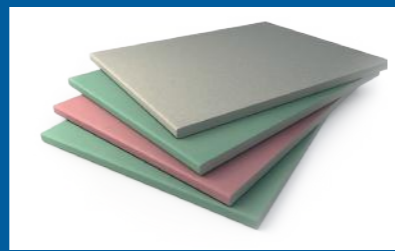

Plasterboard

Multi-purpose construction boards, coated with cardboard on both faces, with plaster in the center. There are 4 different types of plasterboard which are standard, water resistant, fire-resistant and water and fire resistant plasterboards. Due to high air permeability, provides significant contribution in balancing ambient humidity, and in ensuring sound and heat insulation when used with proper insulation material.



Joint Tape

A type of netting used to equally block joints remaining between plasterboards using joint sealant and to prevent cleavage at the joint points.



Steel Wall Plug

A fitting used in the mounting of ceiling U profiles on the floor.



Insulation Material

Mineral wool of different density and thickness values used to increase heat insulation, sound insulation and resistance to fire.

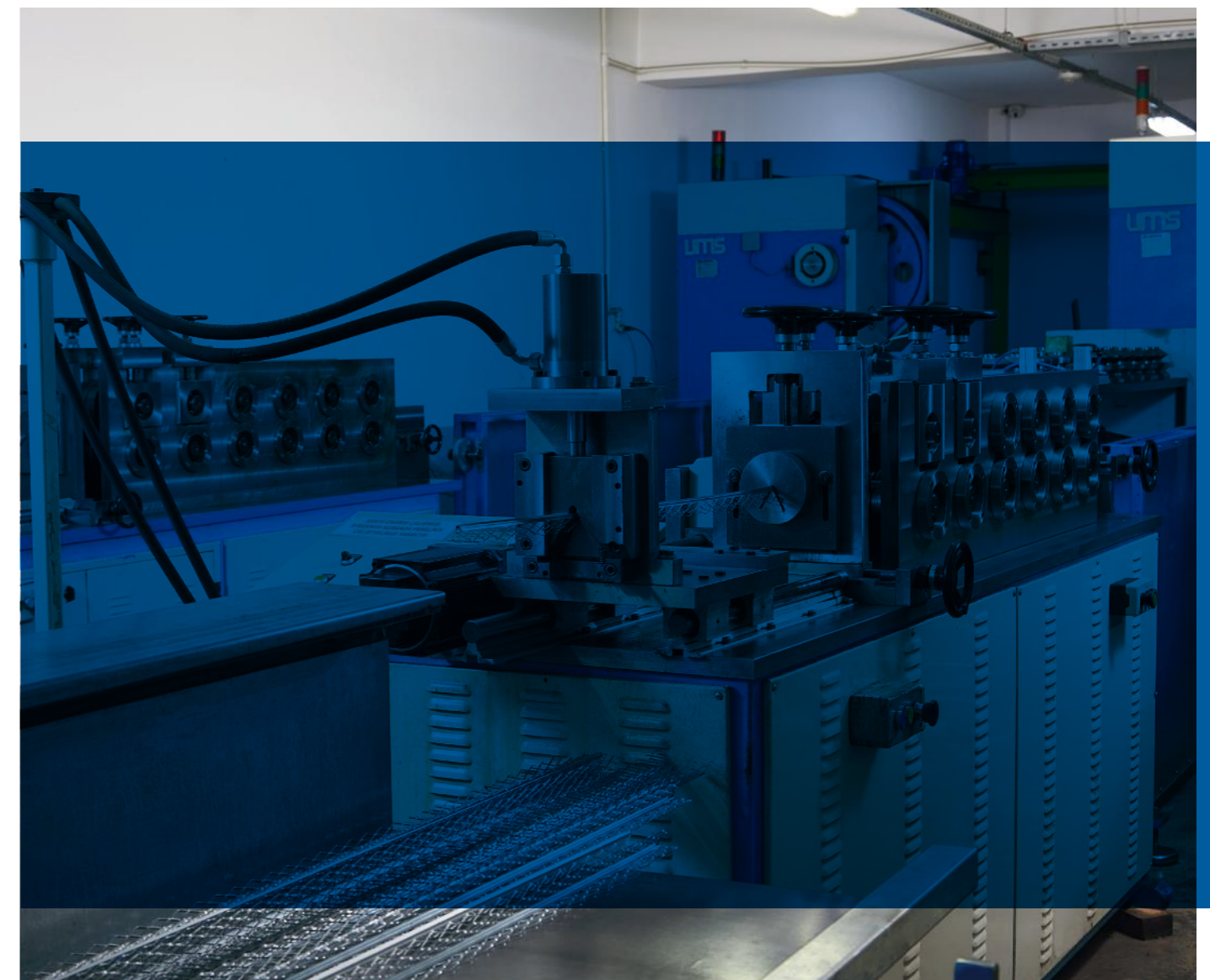

APPLICATION TYPES

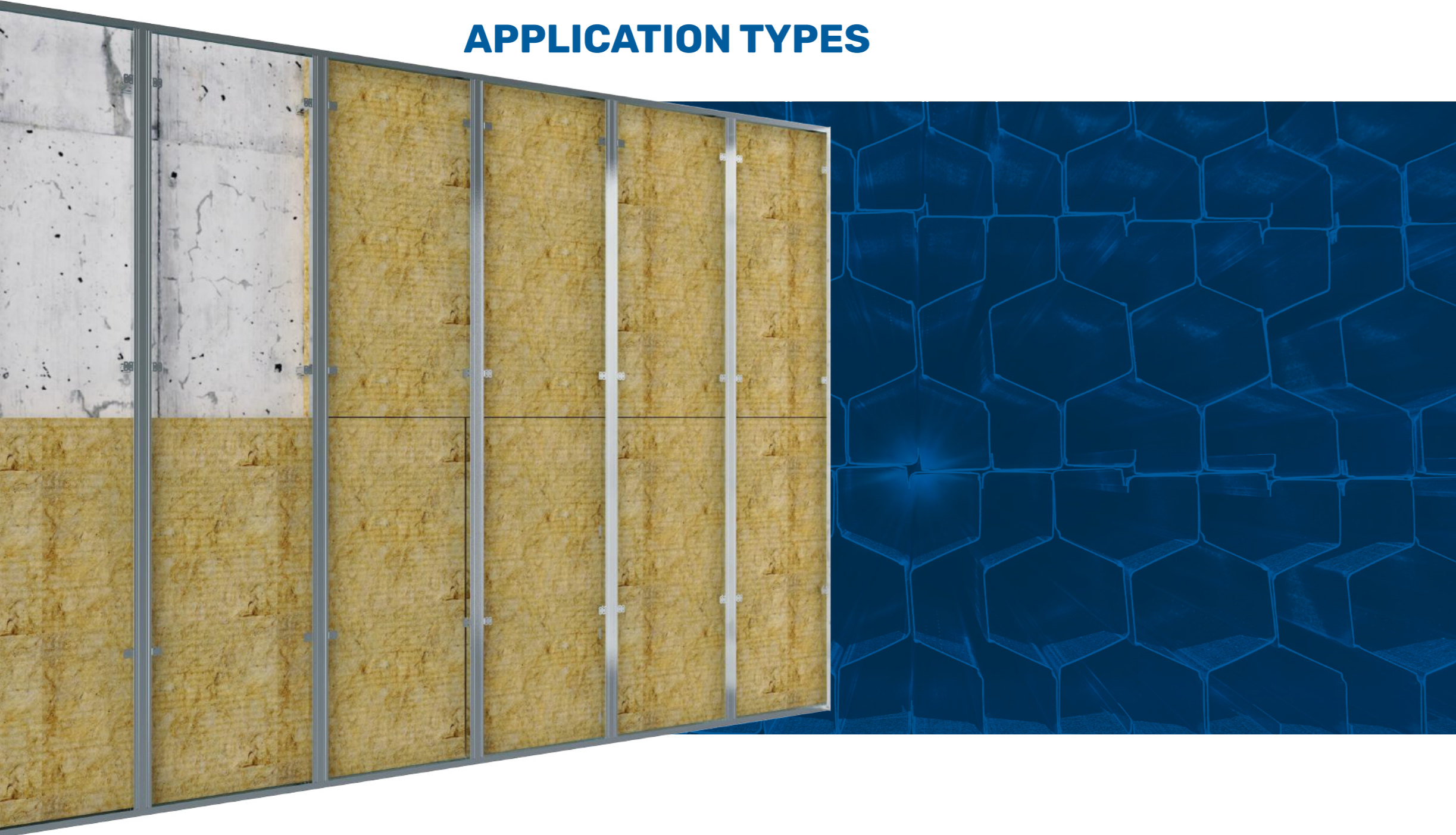

APPLICATION OF WALL CLADDING DEPENDENT ON EXISTING WALL

This is a wall cladding system consisting of bracket, Ceiling U, Ceiling C Profiles and plasterboards mounted on these profiles. Brackets are used to adjust carrying and variations from the plumb line, Ceiling U profiles are used to form a frame, Ceiling C profiles are used to ensure plasterboard connections and vertical points of support.

APPLICATION

Material consumptions given in analysis table can be utilized for the quantity of materials to be consumed. UMS has specified limit values to be taken into consideration for application of wall cladding dependent on existing wall in the table on the next page.

For a proper and complete application of wall cladding system dependent on existing wall, order of operations on the next page should be followed.

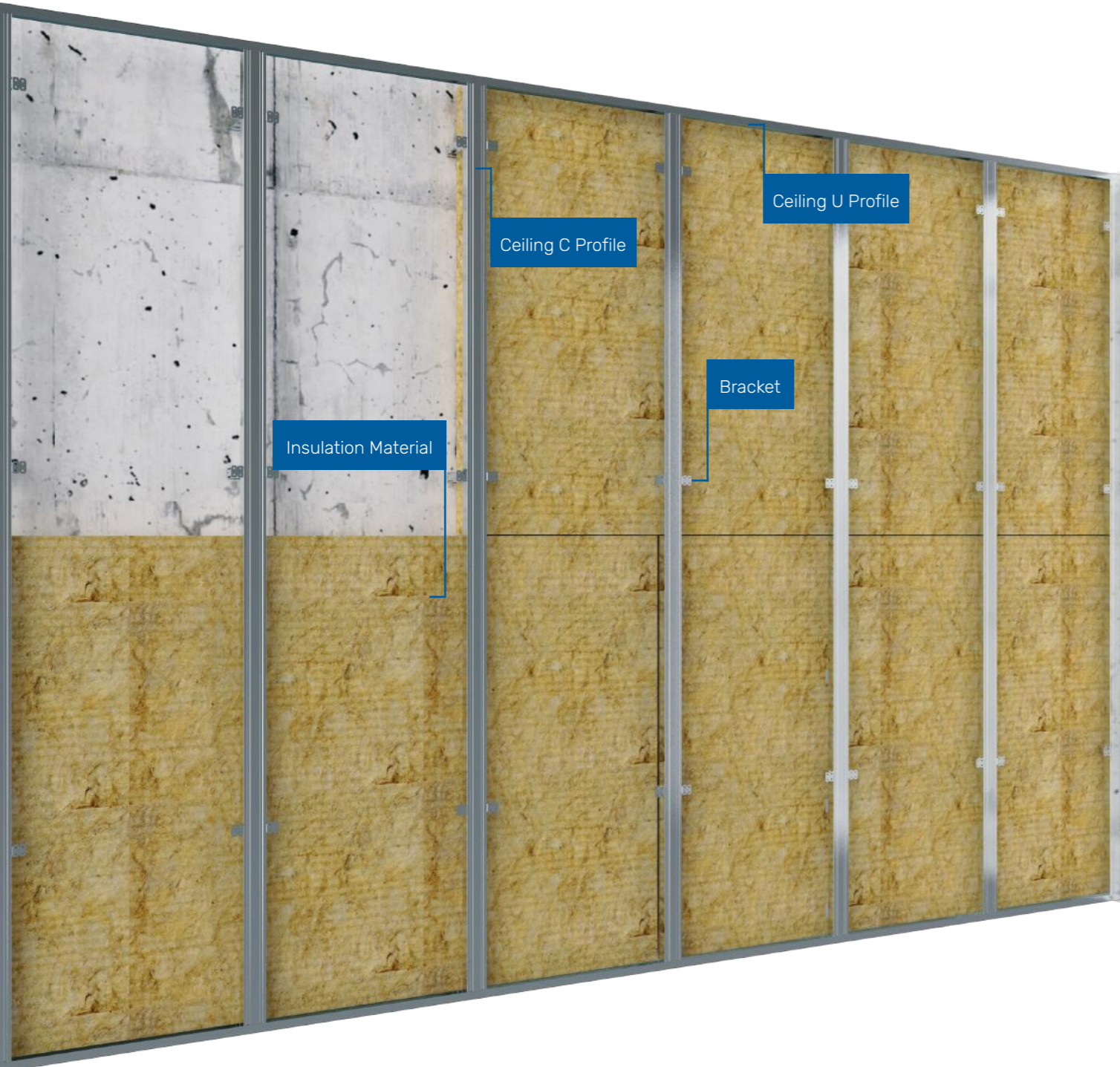

For proper application,

LIMIT VALUES FOR WALL CLADDING DEPENDENT ON EXISTING WALL

DESCRIPTION	LIMIT VALUE
Bracket Spacing:	must be maximum 600 mm horizontally maximum 1500 mm vertically
Ceiling C Profile Spacing	must be maximum 600 mm
Plasterboard Screw Spacing	must be maximum 300 mm
Distance of Ceiling U Profile Starting and Ending Wall Plug Connections to Walls:	must be maximum 50 mm
Ceiling U Profile Wall Plug Spacing:	must be maximum 600 mm

SYSTEM ANALYSIS FOR WALL CLADDING SYSTEM DEPENDENT ON EXISTING WALL

Type of Material	Single Coat Plasterboard (Axial Spacing mm)		Double Coat Plasterboard (Axial Spacing mm)	
Plasterboard:	600	400	600	400
Wall U Profile:			7,56 m	
Wall C Profile:	18,90 m	27,00 m	18,90 m	27,00 m
Sound Insulation Tape:			11,70 m	
Wall plug-Screw:			23 pcs	
Bracket:			15 pcs	
Bracket Screw:			30 pcs	
Drywall Screw 25:	117 pcs	153 pcs	81 pcs	99 pcs
Drywall Screw 28:	-	-	117 pcs	153 pcs
Joint Tape:			14,40 m	
Perforated Corner Profile:	varies depending on (floor height) x (number of corners)			

* 5 % wastage is taken into account for a 9m² of WALL CLADDING at 2,50 m Height. Quantities may vary depending on the project details.

* Consumptions may vary depending on project details.

Order of operations given below should be followed for a complete application.



STEP 1

Location of Ceiling U profiles to be applied to the floor and ceiling is determined using auxiliary equipment including laser, chalk line, water balance etc.

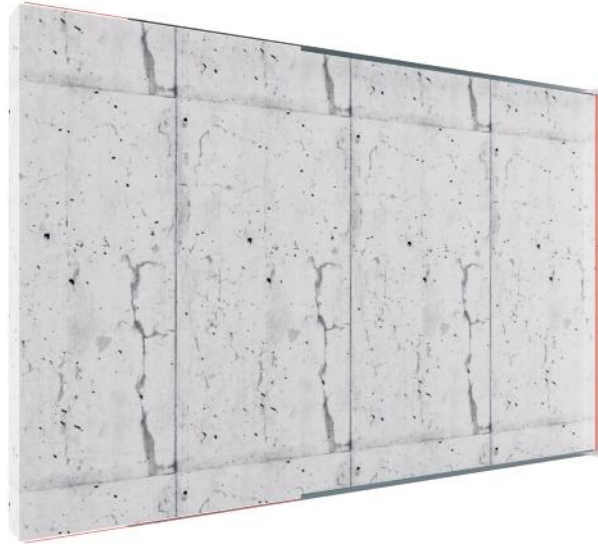

STEP 2

Ceiling U profiles, as sound insulation tape applied to the side that faces ceiling and floor, are fixed to the ceiling and floor with a distance of 50 mm from both ends and with a spacing of 600 mm, using suitable type of wall plug.

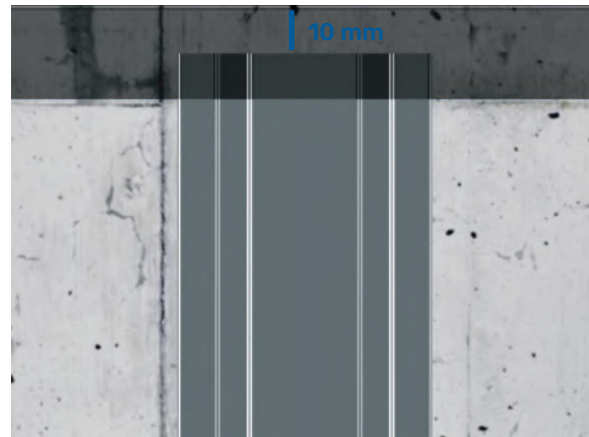

STEP 3

Wall C profiles to be used vertically are cut 10 mm shorter than ceiling height.

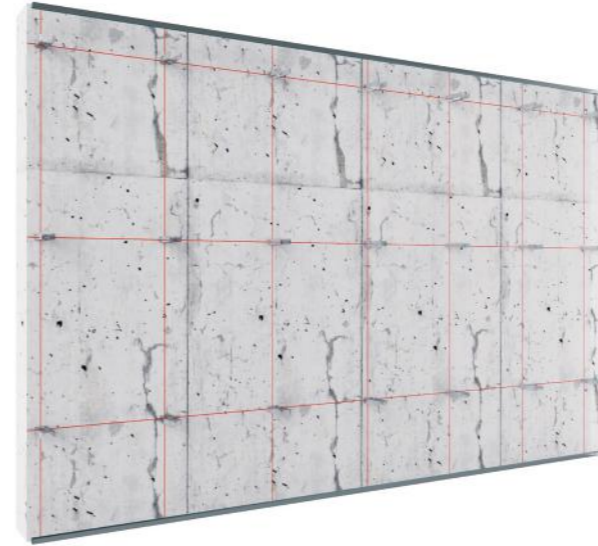

STEP 4

Brackets required for fastening of Ceiling U profiles are mounted on the wall surface using wall plugs-screws, with a spacing of maximum 600 mm horizontally and maximum 1500 mm vertically.



STEP 5

Ceiling U profiles are leveled into brackets and placed in Ceiling U profile on the floor and fixed using metal-to-metal screws. In cases where it is not possible to use Ceiling U in the ceiling, the last bracket should be mounted by leaving a maximum distance of 50 mm from the ceiling.



STEP 6

Wings that jut out following Ceiling C profiles are screwed to brackets are bended sideways or cut using suitable scissors.



STEP 7

After Ceiling C profiles are mounted, insulation materials, if any in the project, are mounted and installation is applied.

Wall cladding dependent on existing wall system is completed.

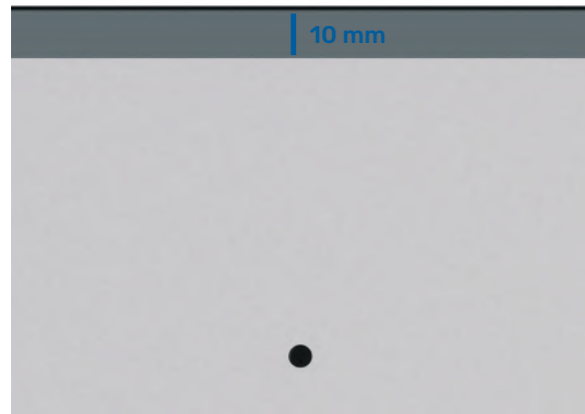

STEP 8

Plasterboards are cut in accordance with the project and 10 mm shorter than ceiling height. Cut plaster boards are mounted onto Ceiling C profiles as staggered, leaving a 10-mm margin from the floor, with suitable screws and screw spacings.

*Following steps are written with reference to plaster board application. Order and content of steps may vary when different materials are used.

STEP 9

Wall C profiles to be used vertically are cut 10 mm shorter than ceiling height.

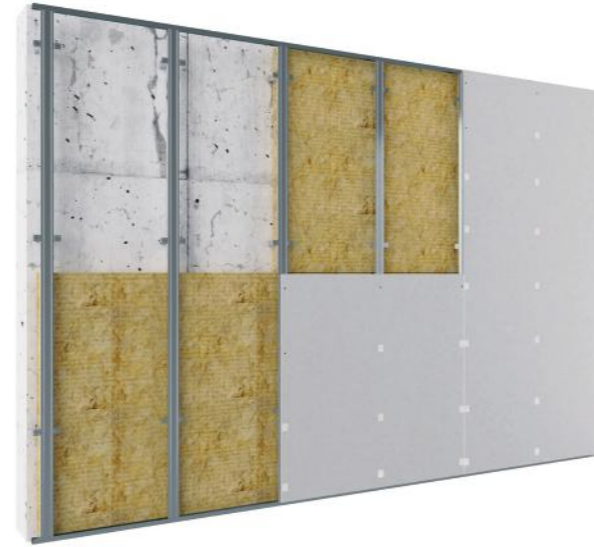
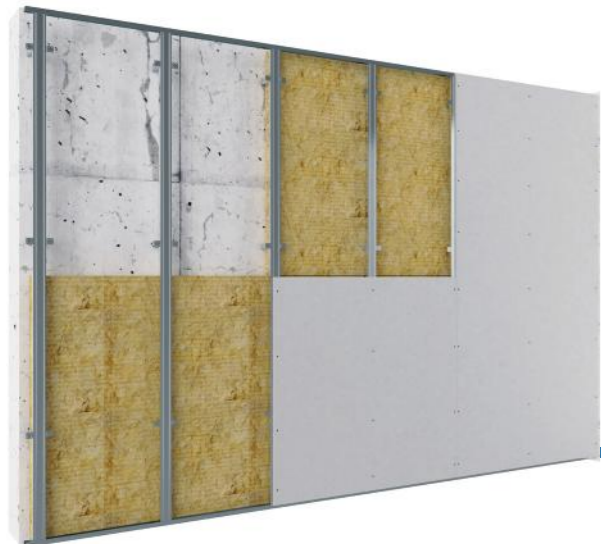

STEP 10

Plaster board joints are covered using joint tapes of appropriate thickness and width according to the project. Covered joints and screw heads are filled with suitable jointing plaster, after the filling plaster dries, treated area is sandpapered and leveled with the board.

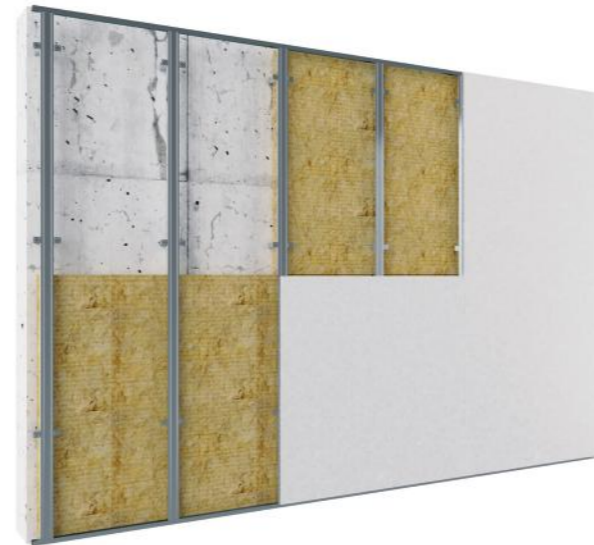

STEP 11

Satin plaster is applied, the surface is sandpapered.

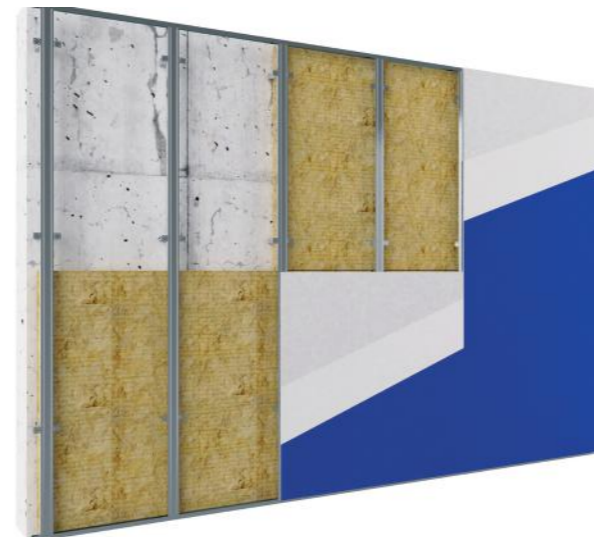

STEP 12

Application is completed by applying primer and paint.

APPLICATION TYPES

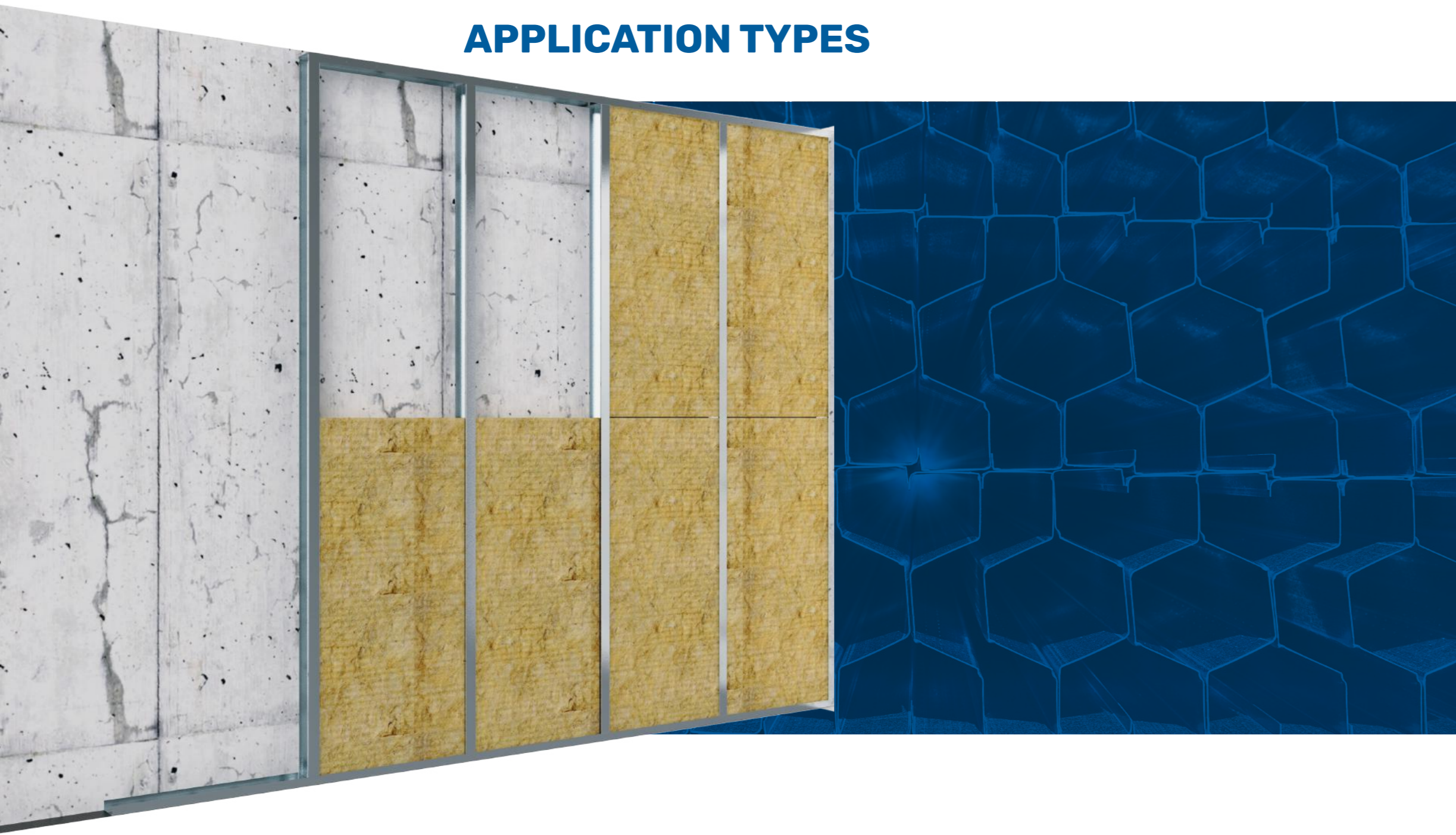

APPLICATION OF WALL CLADDING INDEPENDENT OF EXISTING WALL

This is a wall cladding system independent of existing wall, consisting of Wall U and Wall C Profiles and plasterboards mounted on these profiles. Wall U profile is used to form a frame and provide guidance while Wall C profiles are used to provide plasterboard connections and form vertical support points.

APPLICATION

Material consumptions given in analysis table can be utilized for the quantity of materials to be consumed. UMS has specified limit values to be taken into consideration for application of wall cladding dependent on existing wall in the table on the next page.

For a proper and complete application of wall cladding system dependent on existing wall, order of operations on the next page should be followed.

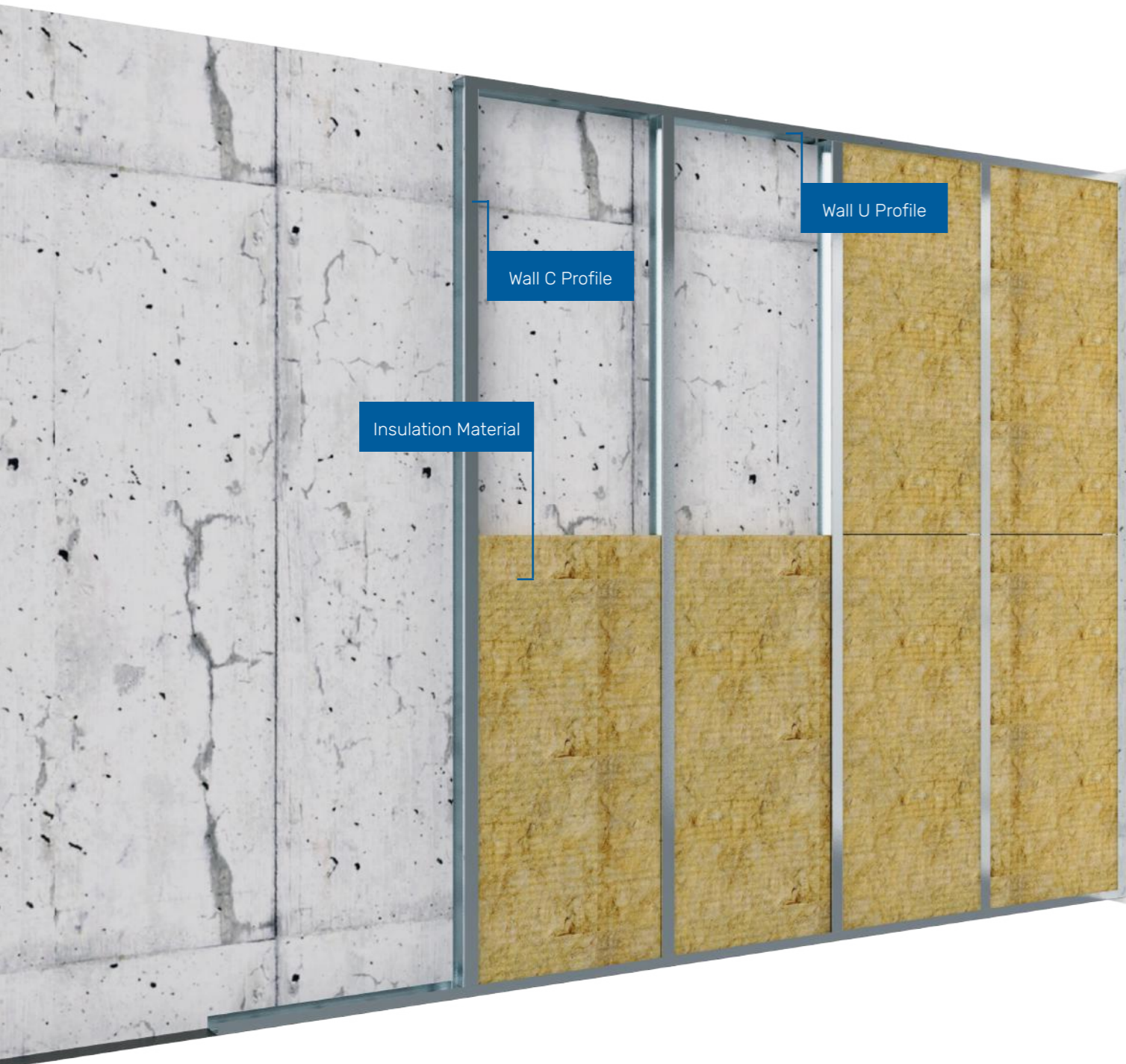

For proper application,

LIMIT VALUES FOR WALL CLADDING INDEPENDENT OF EXISTING WALL

DESCRIPTION	LIMIT VALUE
Wall C Profile:	must be maximum 600 mm
Plaster Board Screw Spacing:	must be maximum 300 mm
Wall U Profile Wall Plug Spacing:	must be maximum 600 mm
Distance of Wall U Profile Starting and Ending Wall Plug Connections to the Walls:	must be maximum 50 mm

SYSTEM ANALYSIS FOR WALL CLADDING INDEPENDENT OF EXISTING WALL

Type of Material	Single Coat Plasterboard (Axial Spacing mm)		Double Coat Plasterboard (Axial Spacing mm)	
	600	400	600	400
Plasterboard:	600	400	600	400
Wall U Profile:			7,56 m	
Wall C Profile:	18,90 m	27,00 m	18,90 m	27,00 m
Sound Insulation Tape:			11,70 m	
Wall plug-Screw:			23 pcs	
Drywall Screw 25:	117 pcs	153 pcs	81 pcs	99 pcs
Drywall Screw 28:	-	-	117 pcs	153 pcs
Joint Tape:			14,40 m	
Perforated Corner Profile:	varies depending on (floor height) x (number of corners)			

* 5 % wastage is taken into account for a 9m² of WALL CLADDING at 2,50 m Height. Quantities may vary depending on the project details.

* Consumptions may vary depending on project details.

Order of operations given below should be followed for a complete application.

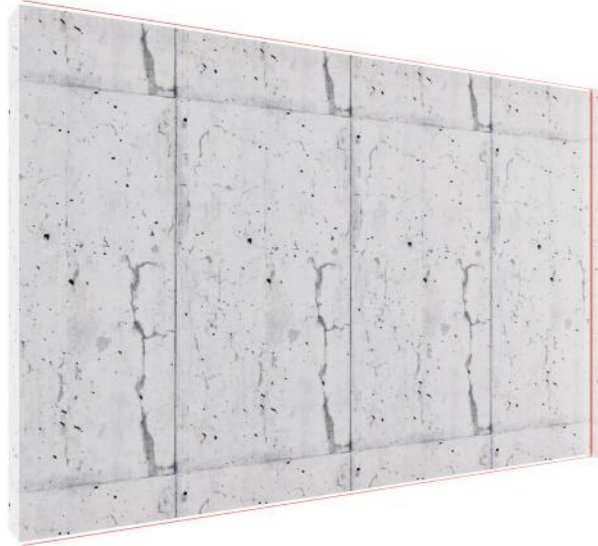

STEP 1

Location of Wall U profiles to be applied to the floor and ceiling is determined using auxiliary equipment including laser, chalk line, water balance etc.



STEP 2

Wall U profiles, as sound insulation tape applied to the side that faces ceiling and floor, are fixed to the ceiling and floor with a distance of 50 mm from both ends and with a spacing of 600 mm, using suitable type of wall plug.

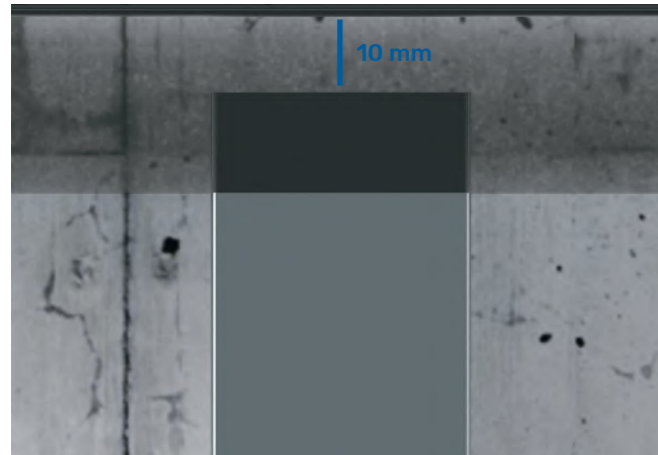

STEP 3

Wall C profiles to be used vertically are cut 10 mm shorter than ceiling height.

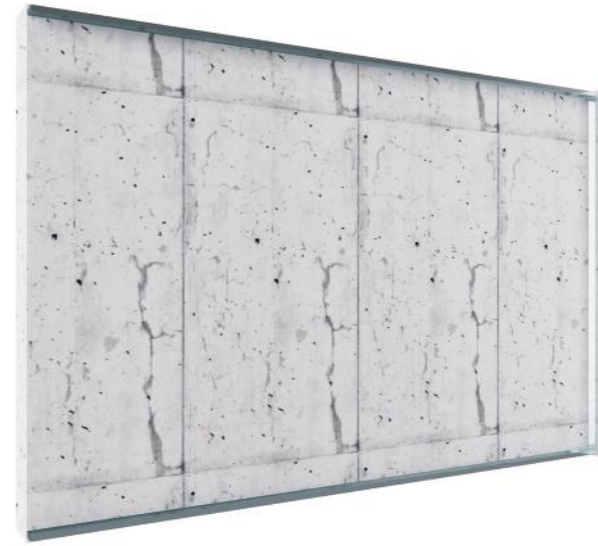

STEP 4

The first Wall C Profile is fixed to the wall surface to be started using wall plug and screw.



STEP 5

Other Wall C profiles are turned and placed between Wall U profiles with maximum 600 mm spacing horizontally according to direction of plasterboard application.



STEP 6

After Wall C profiles are mounted, insulation materials, if any in the project, are mounted and installation is applied between Wall C profiles.

Wall cladding system independent of existing wall is completed.

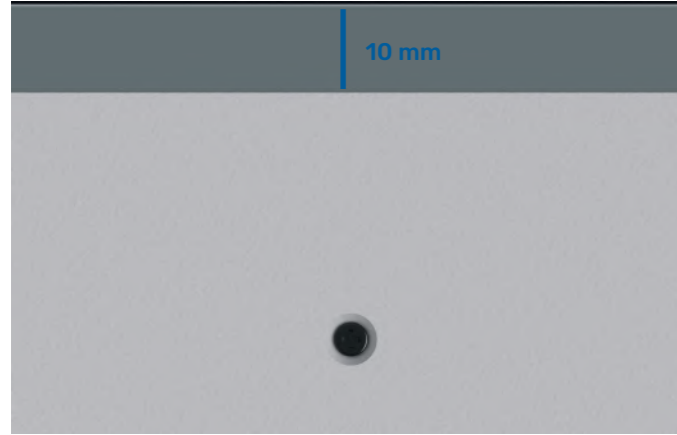

STEP 7

Plasterboards are cut in accordance with the project and 10 mm shorter than ceiling height.



STEP 8

Cut plaster boards are mounted onto Wall C profiles as staggered, leaving a 10-mm margin from the floor, with suitable screws and screw spacings.



STEP 9

Plaster board joints are covered using joint tapes of appropriate thickness and width according to the project. Covered joints and screw heads are filled with suitable jointing plaster, after the filling plaster dries, treated area is sandpapered and leveled with the board.

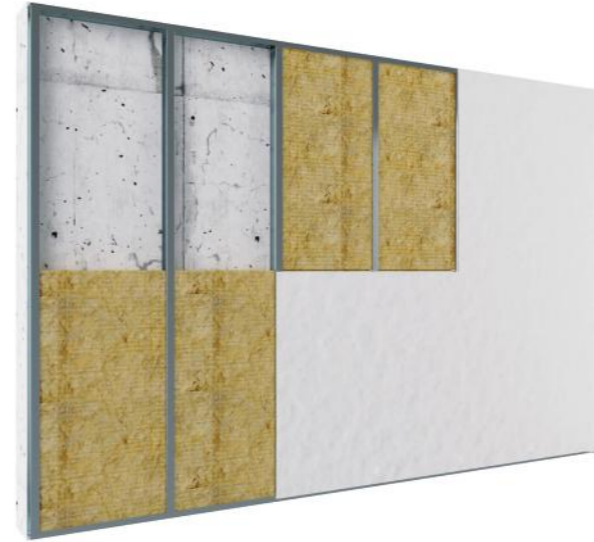

STEP 10

Satin plaster is applied, the surface is sandpapered.

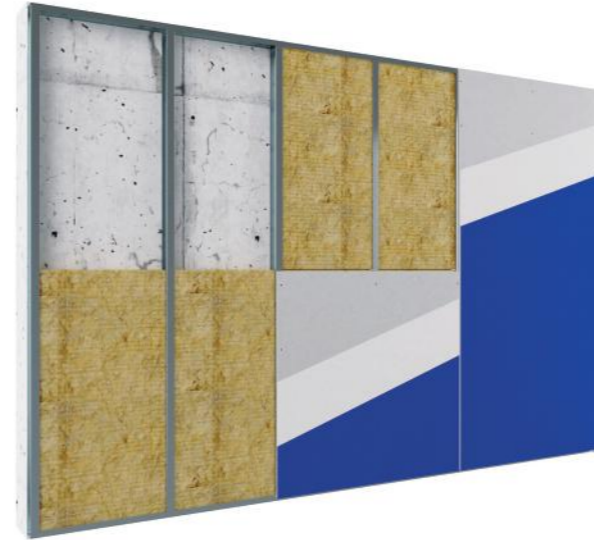

STEP 11

Application is completed by applying primer and paint.

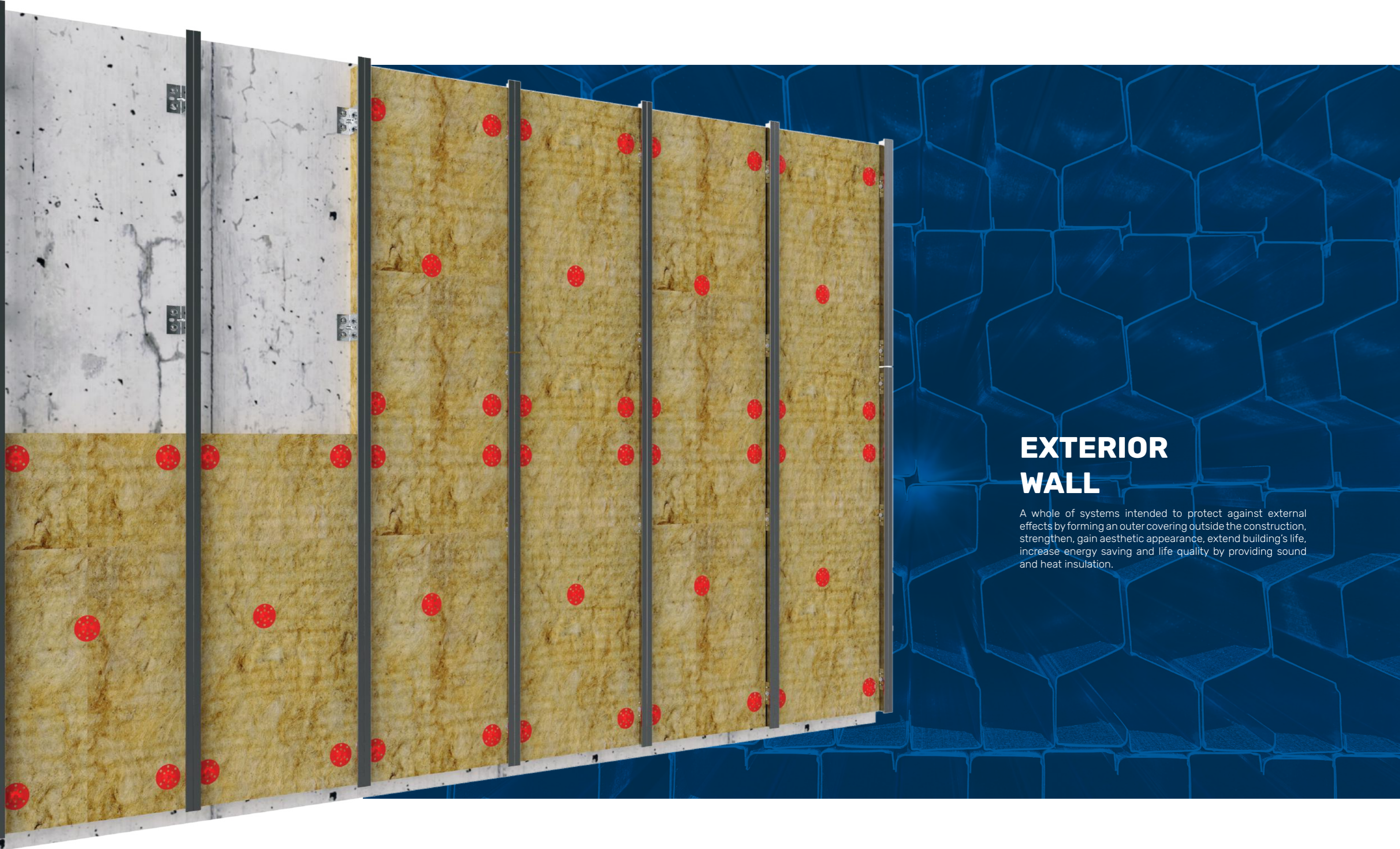

EXTERIOR WALL

A whole of systems intended to protect against external effects by forming an outer covering outside the construction, strengthen, gain aesthetic appearance, extend building's life, increase energy saving and life quality by providing sound and heat insulation.

EXTERIOR WALL SYSTEMS

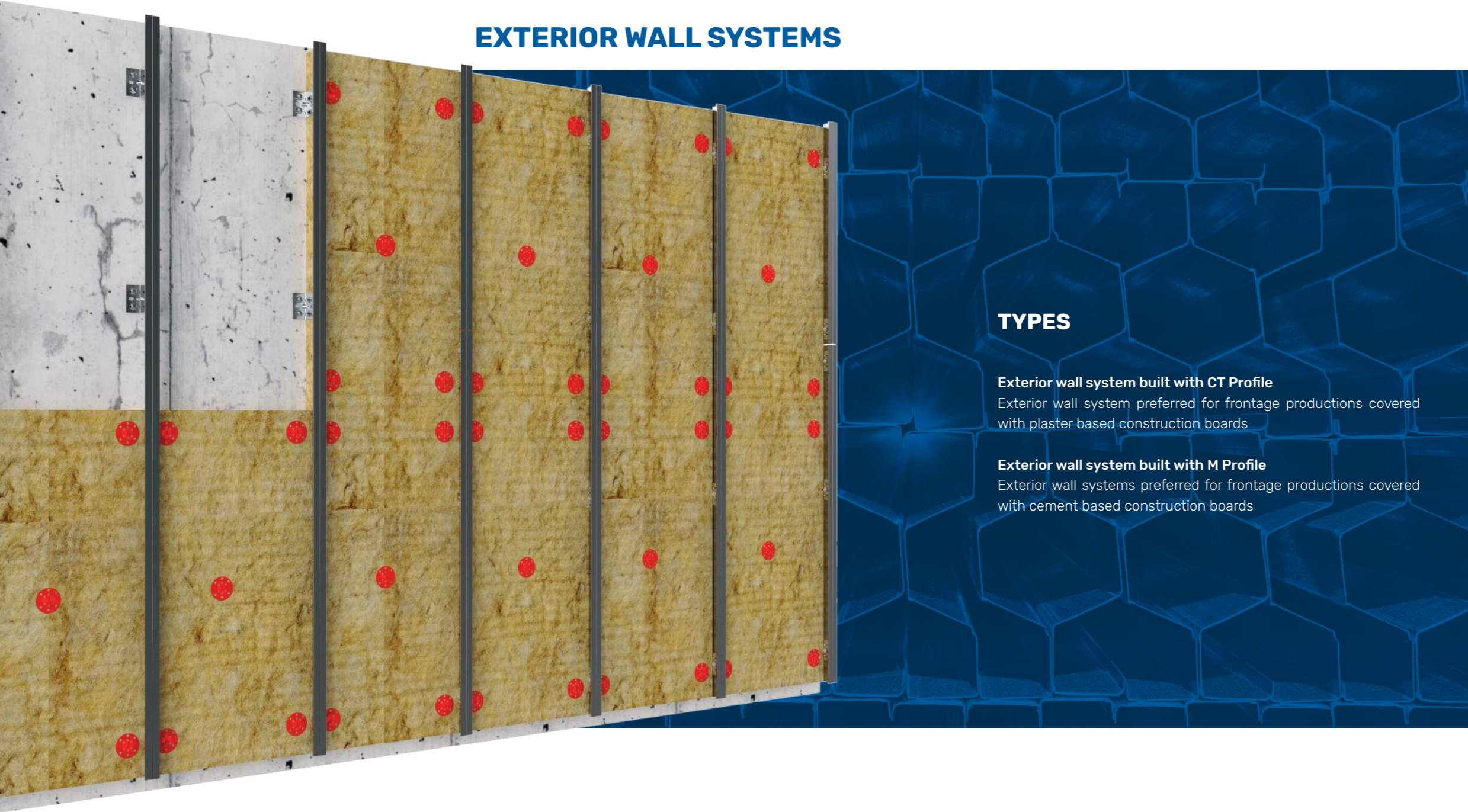

TYPES

Exterior wall system built with CT Profile

Exterior wall system preferred for frontage productions covered with plaster based construction boards

Exterior wall system built with M Profile

Exterior wall systems preferred for frontage productions covered with cement based construction boards

FEATURES

- Protects the construction against external effects,
- Provides formation of a planar surface, with a leveled and smooth wall,
- Provides high level sound and heat insulation if suitable boards and insulating materials are used,
- Saves time and labor as it allows quick and easy mounting-demounting,
- Provides the construction with fire resistance with use of suitable board,
- Does not produce bacteria,
- Economical,
- Aesthetical,

FIELDS OF USE

- Business and shopping centers
- Hospitals
- Schools
- Business centers
- Public buildings
- Housings
- Skyscrapers
- Cottages
- Garden walls

COMPONENTS OF THE SYSTEM



CT Profile

Galvanized frontage profile that forms a carrier surface for plaster boards vertically by attaching to L brackets.



M Profile

Galvanized frontage profile that forms a carrier surface for cement boards vertically by fixing to box or J profiles.



J Profile

Galvanized frontage profile that forms a carrier surface for M profiles horizontally by fixing to L brackets.

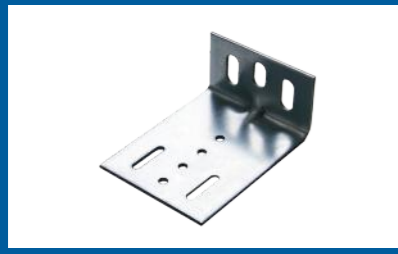

L Bracket

Galvanized L shaped carrier bracket that forms support point for remaining carrier profiles of the system by being fixed to the construction with wall plug and screw.



Sound Insulation Tape

Insulation tape used between the wall and Wall U Profile in order to ensure sound insulation for vibrations caused by the construction.



Trapezoidal Screw

Type of screw used for connecting M profile and L brackets or CT profile and L brackets.



Drywall Screw

Fastener used for mounting gypsum plaster or cement boards on CT or M profiles.



Joint Tape

Type of netting used for filling jointings between gypsum plaster and cement boards at an equal level using filling compound and for preventing crack formation at jointing points.

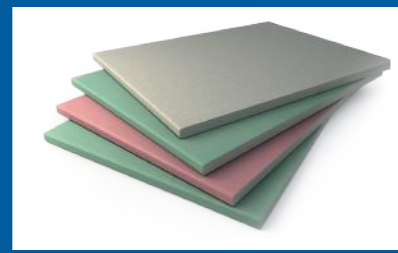

Plasterboard

Multi-purpose construction boards, coated with cardboard on both faces, with plaster in the center. There are 4 different types of plasterboard which are standard, water resistant, fire-resistant and water and fire resistant plasterboards. Due to high air permeability, provides significant contribution in balancing ambient humidity, and in ensuring sound and heat insulation when used with proper insulation material.



Cement Board

Cement based, dyeable or self-dyed multi-purpose construction boards. Due to high air permeability, provides significant contribution in balancing ambient humidity, and in ensuring sound and heat insulation when used with proper insulation material.



Steel Wall Plug

Fasteners used for mounting L brackets on the wall.



Insulation Material

Mineral wool of different density and thickness values used to increase heat insulation, sound insulation and resistance to fire.



APPLICATION TYPES

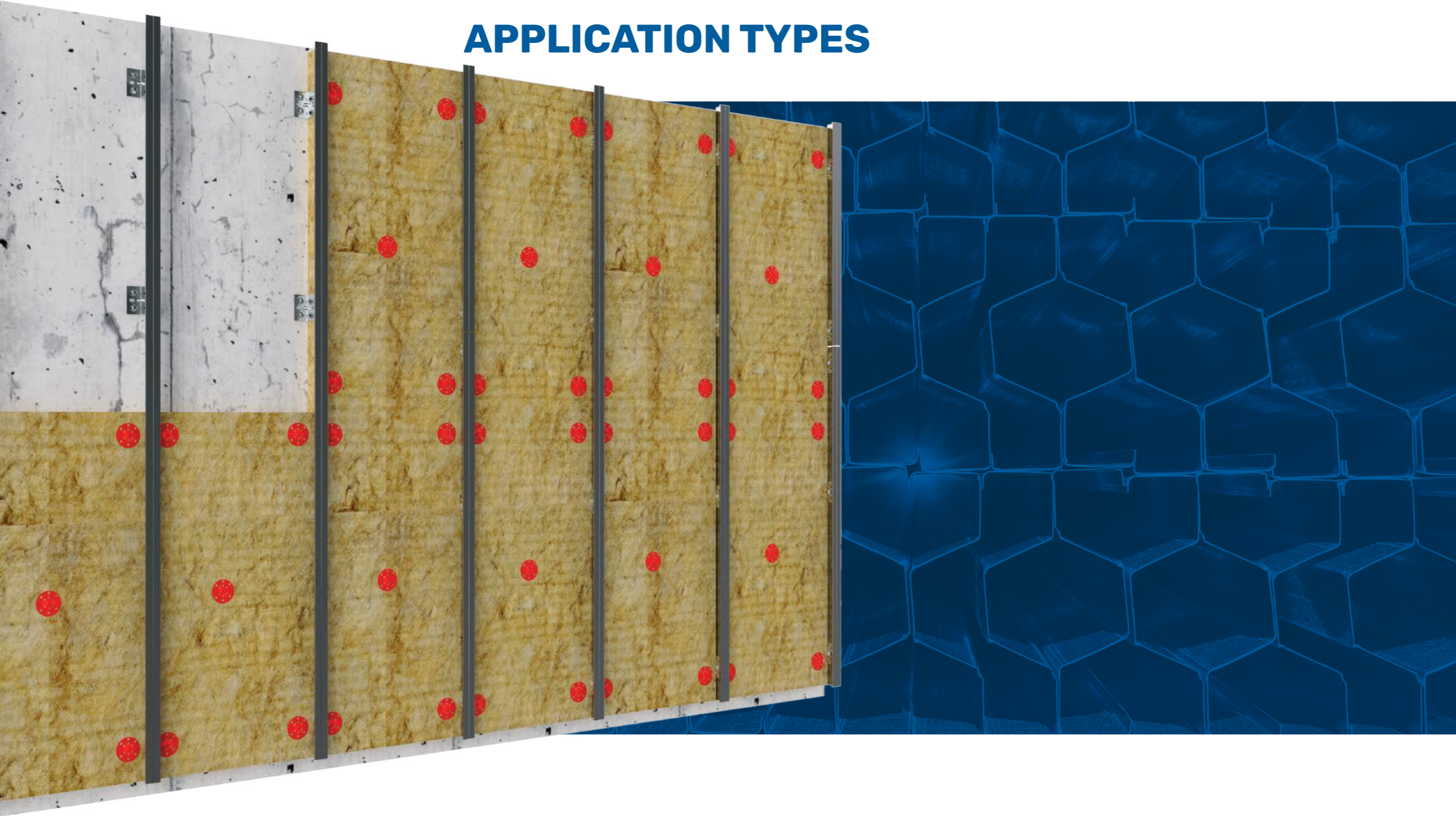

APPLICATION OF EXTERIOR WALL BUILT WITH CT PROFILE

It is an exterior wall system consisting of L bracket, CT Profile and plasterboards suitable for exterior wall mounted on these profiles.

APPLICATION

UMS has specified limit values to be taken into consideration for exterior wall application made with CT profile in the table on the next page. System Analysis Table given on the next page can be utilized for the quantity of materials to be consumed.

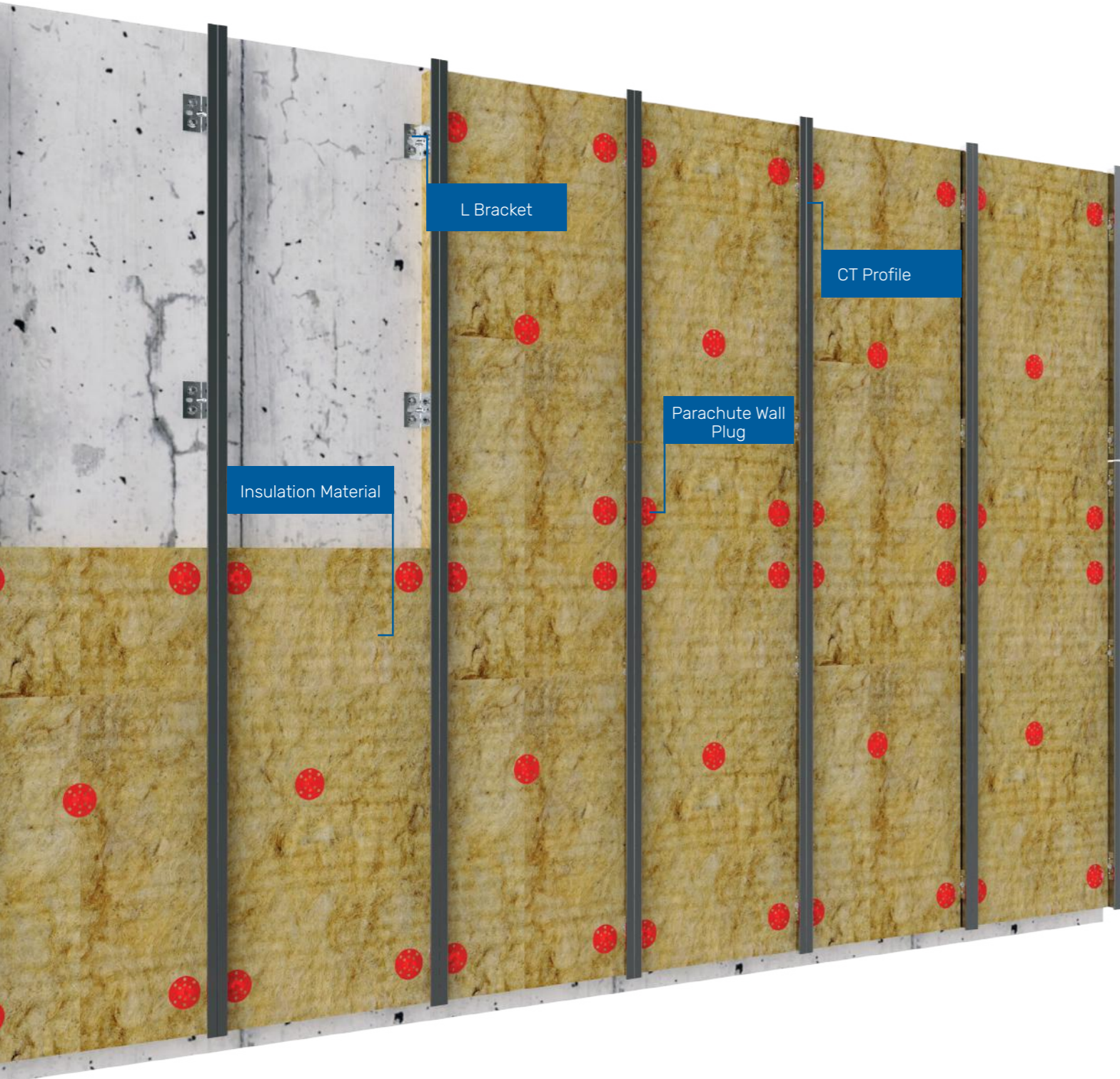

For proper application,

LIMIT VALUES FOR EXTERIOR WALL SYSTEM BUILT WITH CT PROFILE

DESCRIPTION	LIMIT VALUE
L Bracket Spacing:	must be maximum 600 mm horizontally must be maximum 700 mm vertically
CT Profile Spacing:	must be maximum 600 mm
Plaster Board Screw Spacing:	must be maximum 200 mm

SYSTEM ANALYSIS FOR EXTERIOR WALL BUILT WITH CT PROFILE

Type of Material	Axial Spacing (mm)	
	600	400
Cement Board or Plaster Board	9,45 m ²	
CT Profile	17,1 m	25,2 m
L Bracket	25 pcs	36 pcs
Steel Wall Plug	50 pcs	72 pcs
Self-Drilling Screw	50 pcs	72 pcs
Drywall Screw 25	135	180

* 5 % wastage is taken into account for a 9m² of WALL CLADDING at 2,50 m Height. Quantities may vary depending on the project details.

* Consumptions may vary depending on project details.

Order of operations given below should be followed for a complete application.

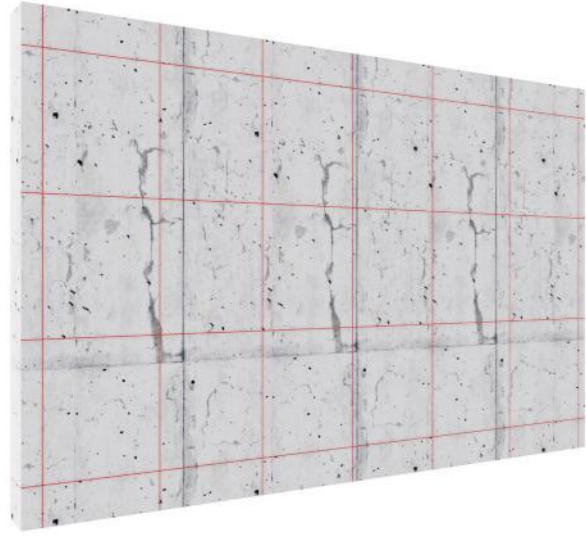

STEP 1

L bracket alignment is determined using auxiliary equipment including laser, chalk line, water balance etc.

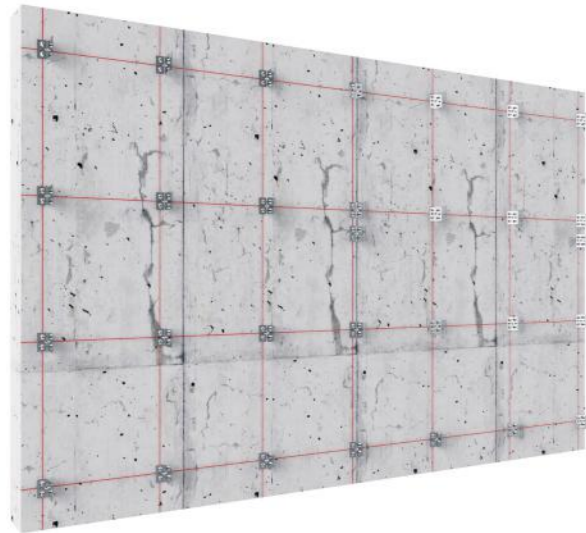

STEP 2

Leaving maximum 600 mm spacing horizontally and maximum 700 mm vertically, L brackets are mounted using suitable couple of wall plug and screw, so that at least two of the three carrier L brackets on the vertical correspond to load-bearing column or joist.

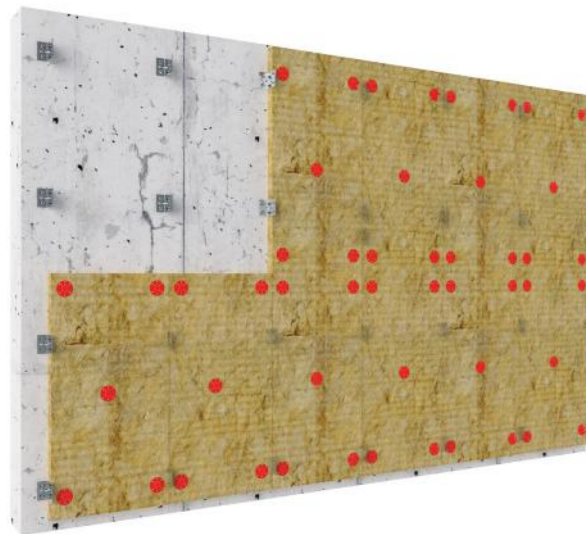

STEP 3

After completion of L anchorage applications, optionally, rockwools are applied to the frontage so as to be coated on L brackets. At least 5 parachute dowels should be mounted on each insulation wool plate, optionally, metal parachute dowels should be mounted at the center points in order to ensure fire resistance.

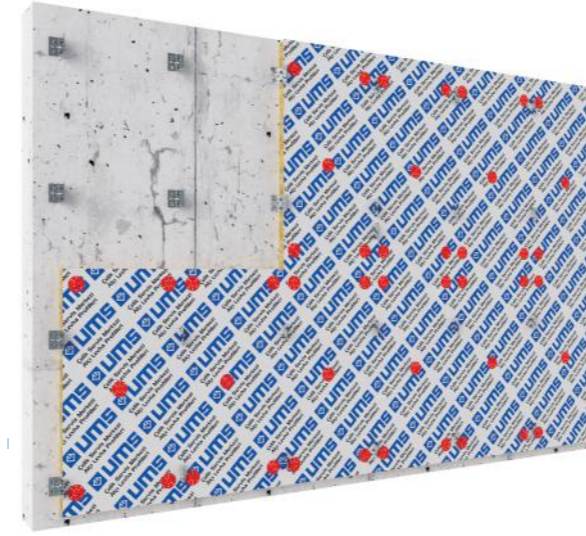

STEP 4

After rockwools are mounted, roller shaped moisture barriers are applied to the frontage so as to overlap. Overlapped surfaces should be covered by means of tape suitable for moisture barrier. Points where moisture barriers are torn by L brackets are covered using insulation tapes.

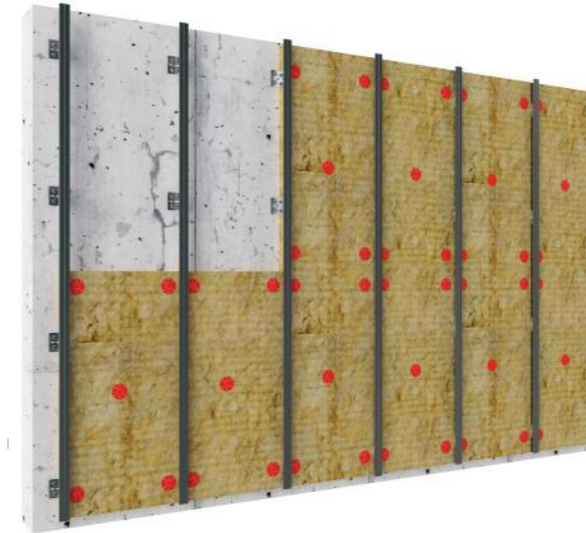

STEP 5

Frontage is leveled and CT profiles are screwed to L brackets with maximum 600 mm spacings using trapezoid screws. When starting from the floor, CT profiles should be applied by leaving at least 50 mm space for waterproofing.

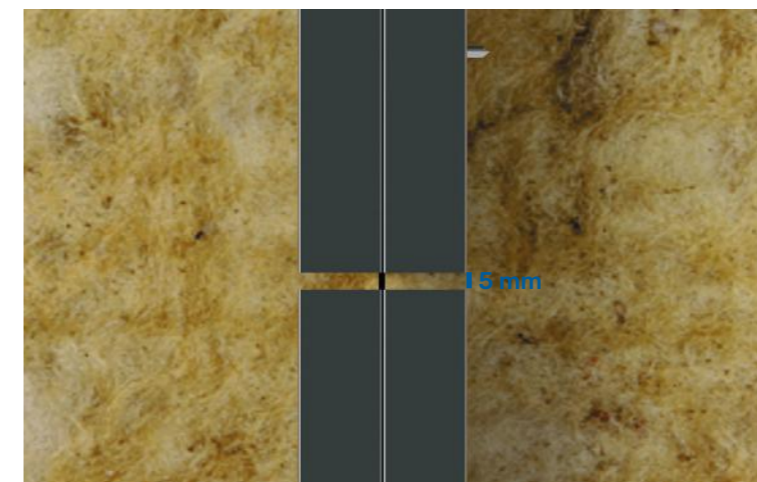

STEP 6

In vertical joinings, in order to ensure operation of the system minimum 5 mm should be left between the two CT profiles.

Exterior wall system built with CT Profile is completed.

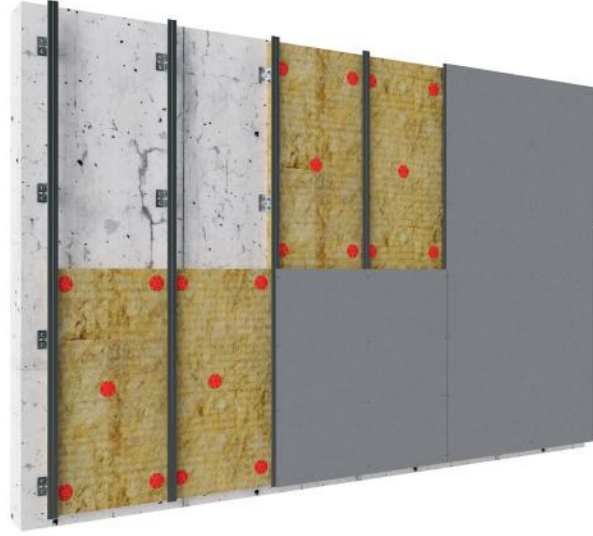

*Following steps are written with reference to plaster based exterior wall board application. Order and content of steps may vary when different materials are used.

STEP 7

Plaster based exterior wall boards are mounted on CT profiles by means of countersunk screws so that they correspond to CT profiles horizontally and with maximum 200 mm spacings vertically. Board mounting should be made in a staggered way.

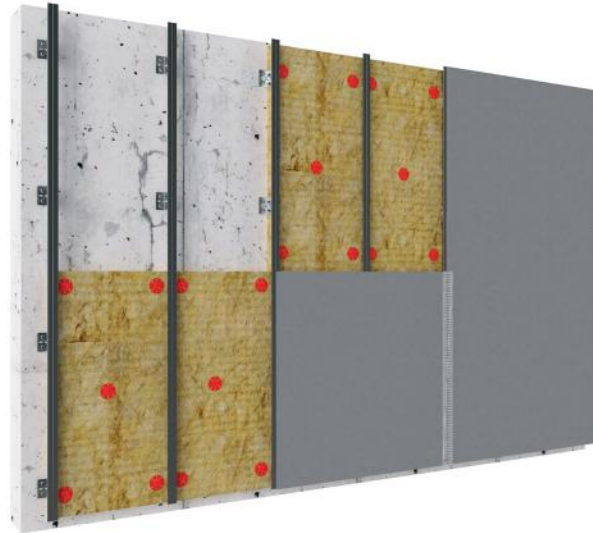

STEP 8

After board mounting is finished, joining points are covered with joint netting.

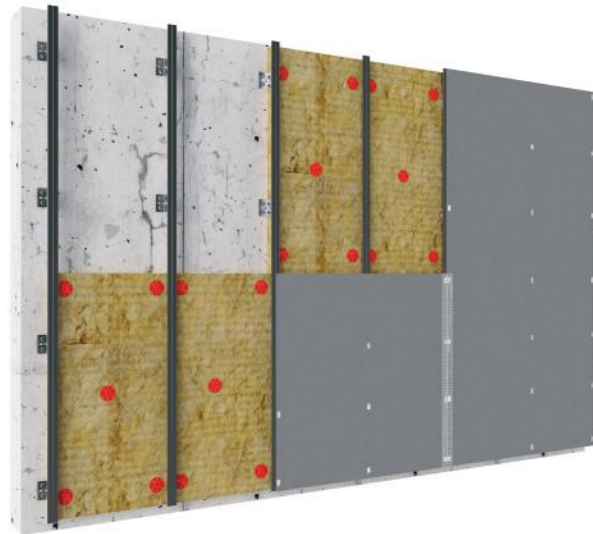

STEP 9

Joint cavities and screw heads are filled with jointing plaster vertically and horizontally. Following drying of jointing plaster, jointing points and screw heads are sanded and leveled with the board.

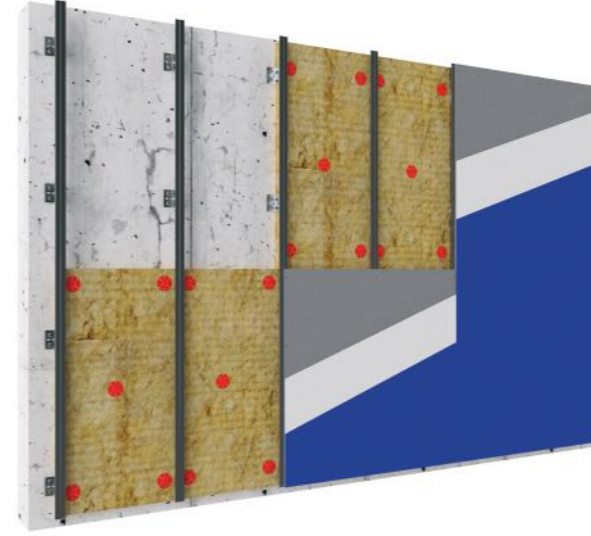

STEP 10

Cement based coating and plaster based board surface is covered at appropriate thickness according to the project. After setting, one coat of exterior wall primer and two coats of exterior wall paint is applied and application is ended.

APPLICATION TYPES

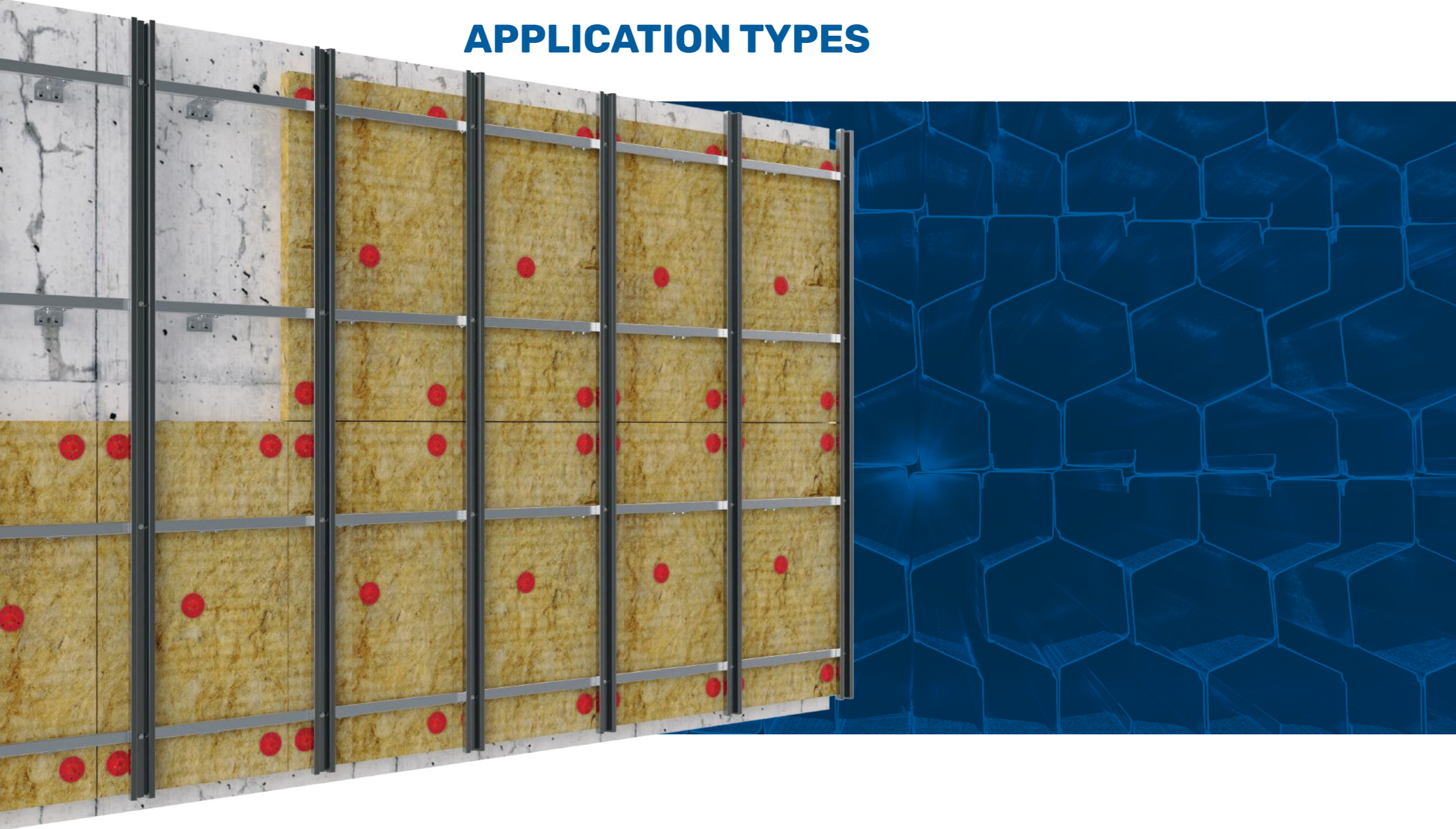

EXTERIOR WALL APPLICATION WITH M PROFILE

Exterior wall system consisting of L bracket, J profile, M profile and cement boards mounted on these profiles.

APPLICATION

UMS has specified limit values to be taken into consideration for exterior wall application made with M profile in the table on the next page. System Analysis Table given on the next page can be utilized for the quantity of materials to be consumed.

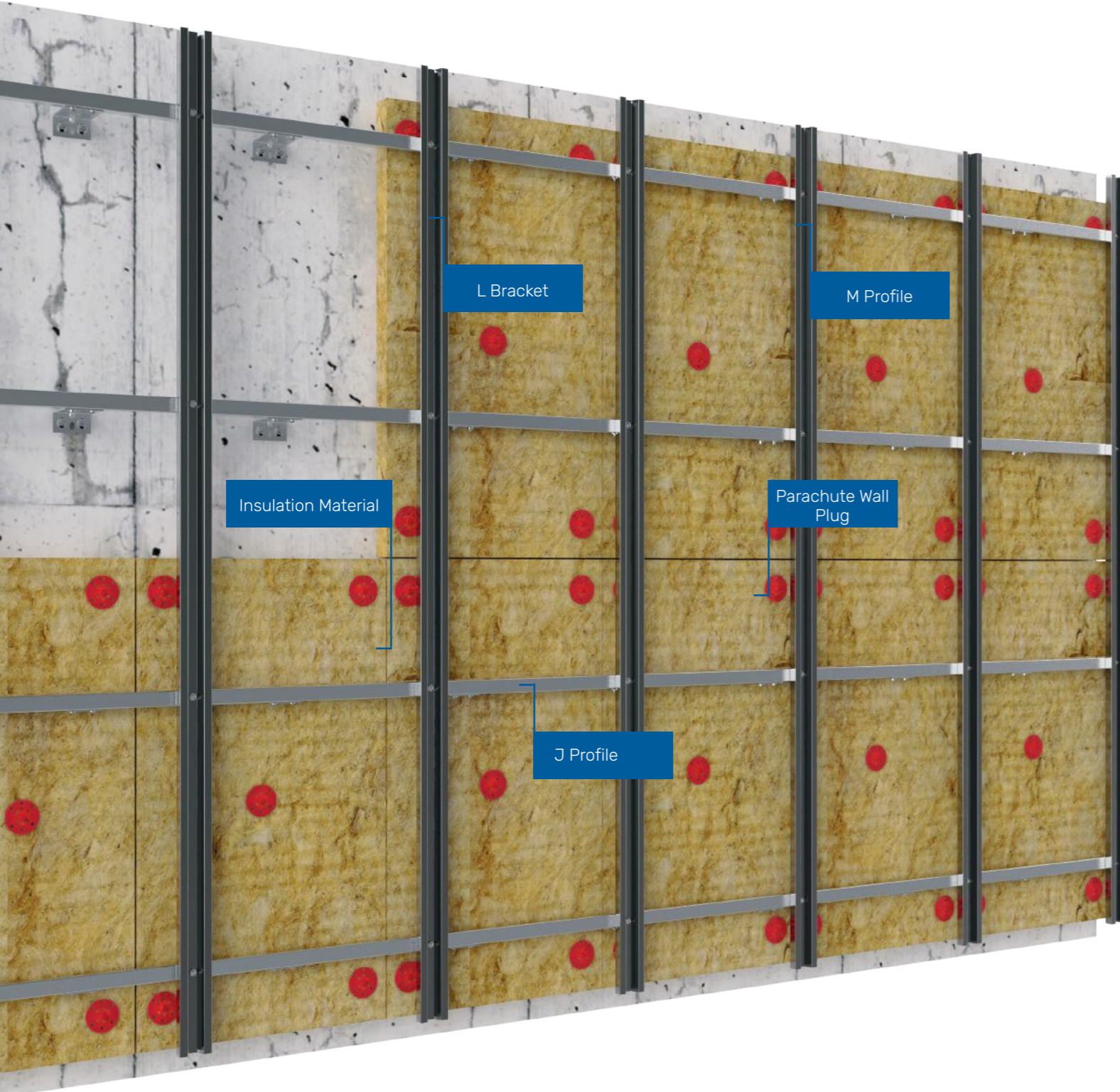

For proper application,

LIMIT VALUES FOR EXTERIOR WALL SYSTEM BUILT WITH M PROFILE

DESCRIPTION	LIMIT VALUE
L Bracket Spacing:	must be maximum 1000 mm horizontally
	must be maximum 1000 mm vertically
J Profile Spacing:	must be maximum 1000 mm
M Profile Spacing	must be maximum 625 mm
Cement Board Screw Spacing	must be maximum 400 mm

SYSTEM ANALYSIS FOR EXTERIOR WALL BUILT WITH M PROFILE

Type of Material	Axial Spacing (mm)	
	600	400
Cement Board or Plaster Board	9,45 m ²	
M Profile	17,1 m	25,2 m
D Profile	14,4 m	
L Bracket	25 pcs	36 pcs
Steel Wall Plug	50 pcs	72 pcs
Self-Drilling Screw	75 pcs	95 pcs
Drywall Screw 25	135	180

* 5 % wastage is taken into account for a 9m² of WALL CLADDING at 2,50 m Height. Quantities may vary depending on the project details.
 * Consumptions may vary depending on project details.

Order of operations given below should be followed for a complete application.

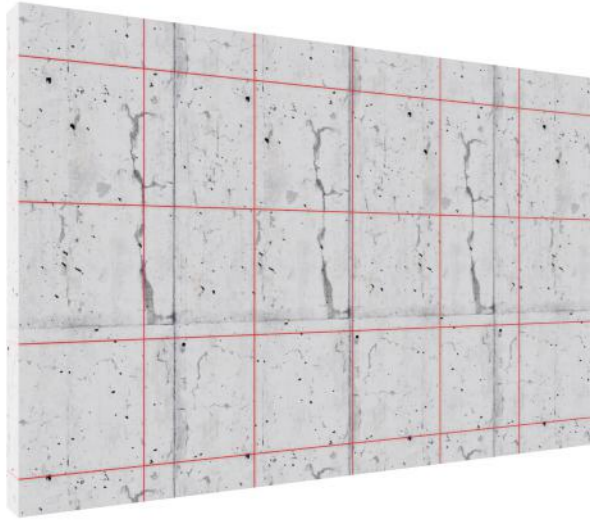

STEP 1

L bracket alignment is determined using auxiliary equipment including laser, chalk line, water balance etc.

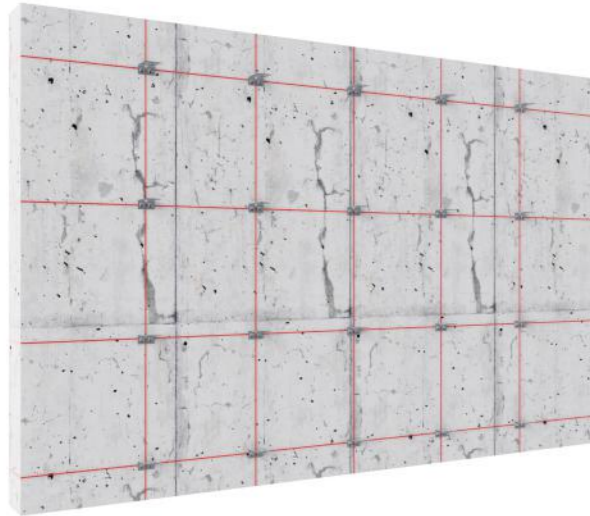

STEP 2

Leaving maximum 1000 mm spacing horizontally and maximum 1000 mm vertically, L brackets are mounted using suitable couple of wall plug and screw, so that at least two of the three carrier L brackets on the vertical correspond to load-bearing column or joist.

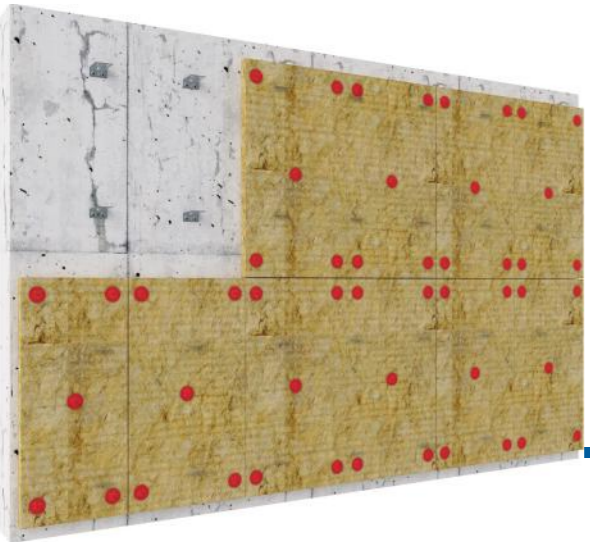

STEP 3

After completion of L anchorage applications, optionally, rockwools are applied to the frontage so as to be coated on L brackets. At least 5 parachute dowels should be mounted on each insulation wool plate, optionally, metal parachute dowels should be mounted at the center points in order to ensure fire resistance.

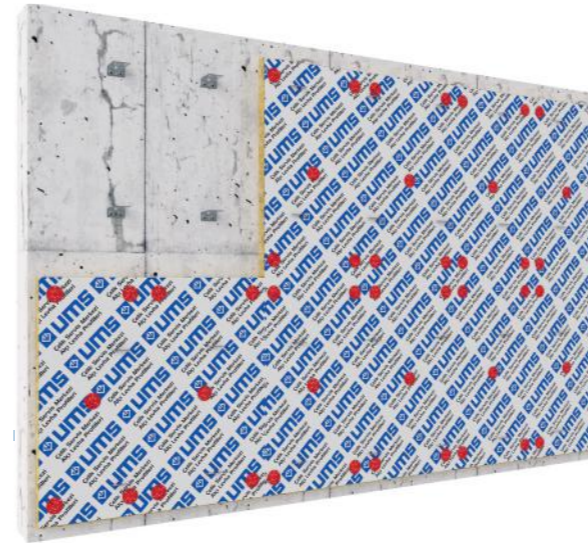

STEP 4

After rockwools are mounted, roller shaped moisture barriers (optionally) are applied to the frontage so as to overlap. Overlapped surfaces should be covered by means of tape suitable for moisture barrier. Points where moisture barriers are torn by L brackets are covered using insulation tapes.

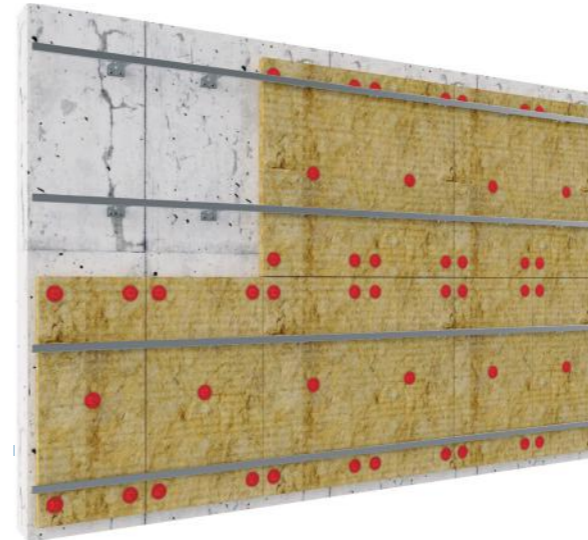

STEP 5

J profiles are mounted using trapezoid screws to form support point horizontally onto anchorages that are attached to the frontage horizontally by means of wall plugs with a maximum spacing of 1000 mm. In J profile application, profiles should be leveled and planar.

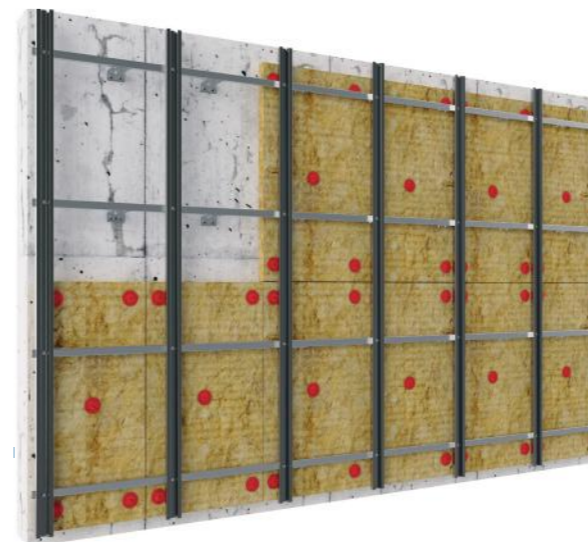

STEP 6

In vertical joinings, at least 5 mm should be left between the two M profiles in order to ensure operation of the system, M profiles level the frontage and are screwed to J profiles using trapezoid screws from the center channel with a maximum spacing of 625 mm. When starting from the floor, J profiles should be applied by leaving at least 50 mm space for waterproofing.

Exterior wall system built with M Profile is completed.

*Following steps are written with reference to cement based exterior wall board application. Order and content of steps may vary when different materials are used.

STEP 7

Cement based exterior wall boards are mounted on M profiles by means of countersunk screws so that they correspond to M profiles horizontally and with maximum 400 mm spacings vertically.

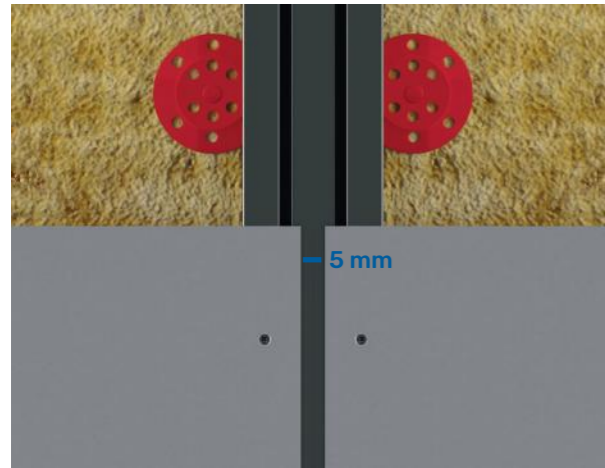
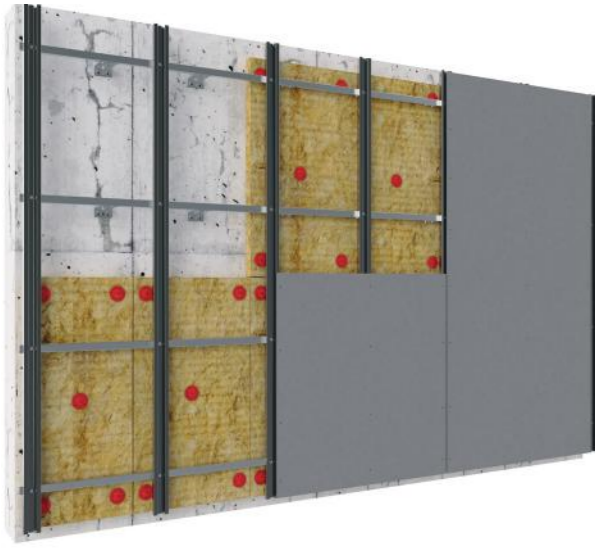

STEP 8

During mounting boards, cement boards should step on M profile at equal amounts and at least 5 mm joint space should be left.

STEP 9

Screwed points are filled using acrylic sealant or polyester sealant. After the sealants dry out points where sealant is applied are sandpapered and leveled with the board.

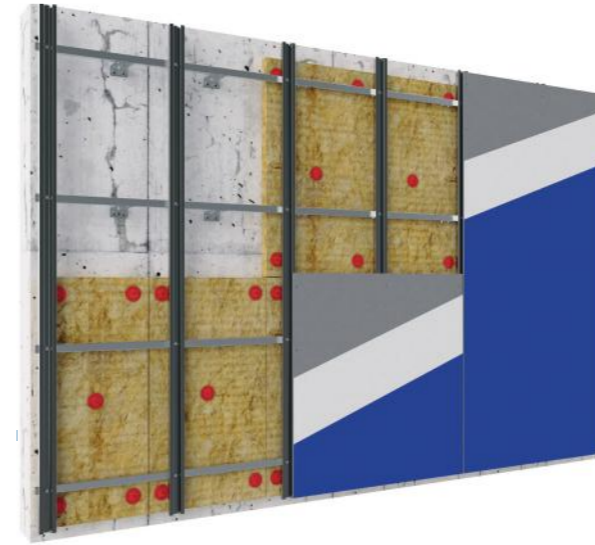
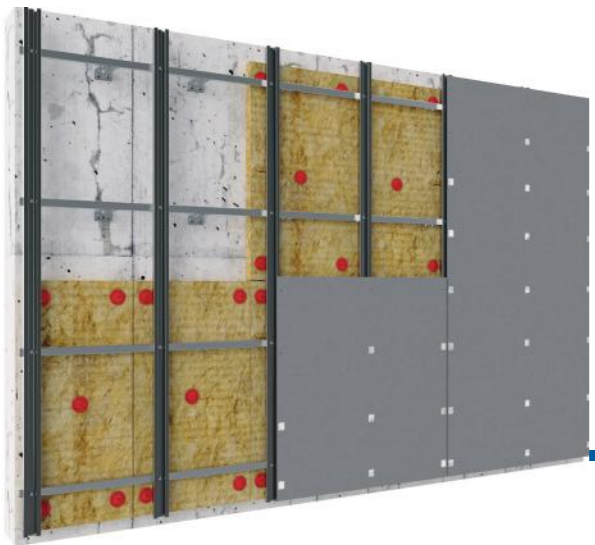

STEP 10

One coat of exterior wall primer and two coats of exterior wall paint is applied and application is completed.



ANKARA-FACTORY
1208. Sokak No: 6-8D-8E Ostim /ANKARA
T: 0312 354 01 06

İSTANBUL-WAREHOUSE
Şerifali Mah. Atabek Sokak No: 27 Ümraniye / İSTANBUL
T: 0216 504 11 57

İZMİR - OFFICE
Fevzi Çakmak Caddesi Türegün İş Hanı
Kat: 6 No: 604 Bornova / İZMİR
T: 0232 339 91 11
ums@umsmetal.com.tr

www.umsmetal.com.tr

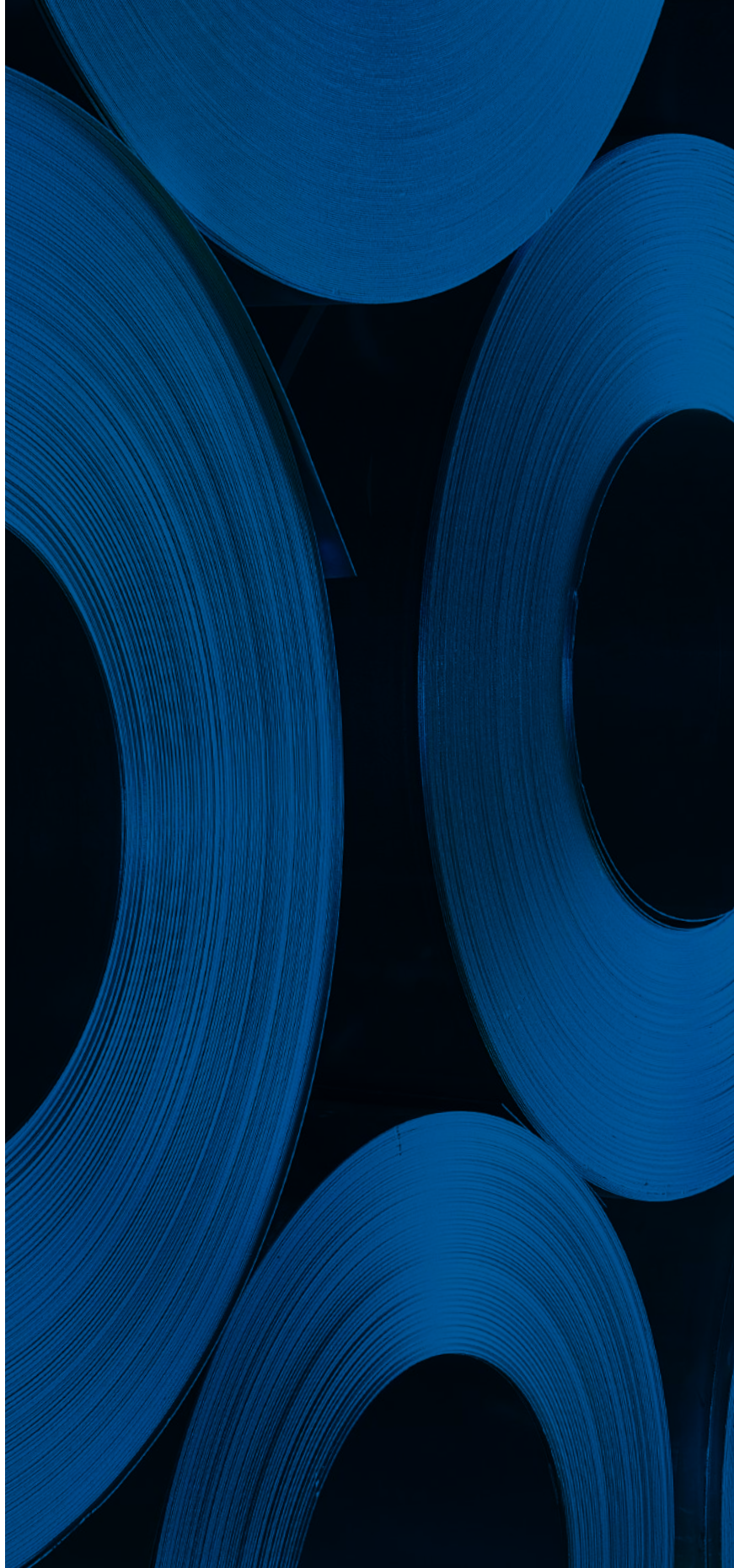

#onestepahead